

Regulator

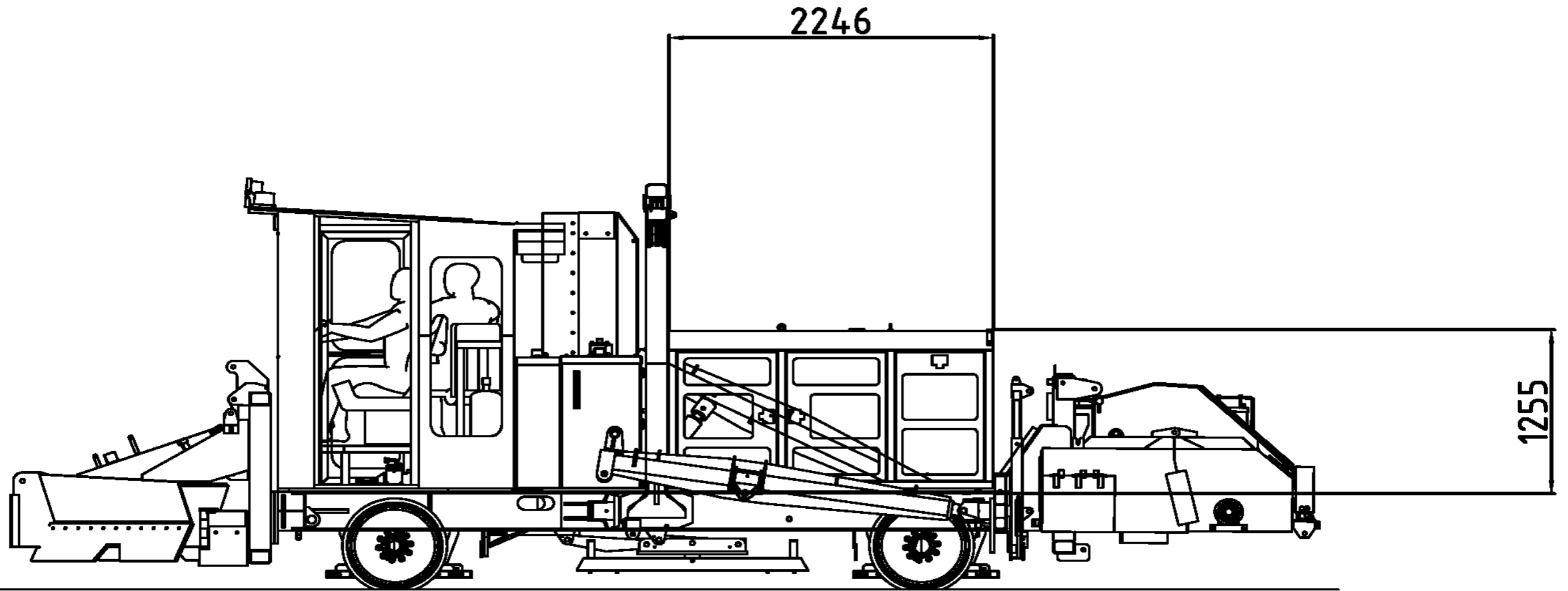

Components :



Manual Actuator



Siren Strobe



VSS Control Panel



FirePro Aerosol Generator - FP-500S

FIRE SAFETY EQUIPMENT PTY LTD				
Drawn By PM	Approved By	Title Regulator FirePro Fire Suppression System	Drawing No Reg - GA	Rev. A
Scale No	Date 15-10-19			

Regulator

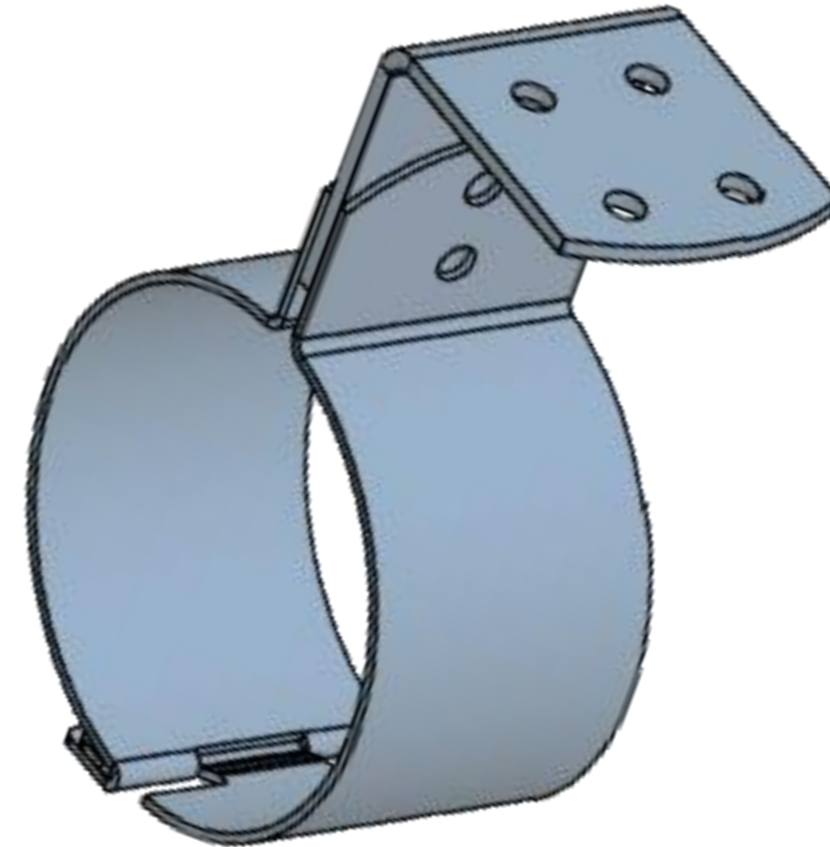

Notes:

- 1 Bracket Material - 316SS
- 2 2 Bracket per FP-0500 required
- 3 Holes in Bracket are for M8 Bolts

FIRE SAFETY EQUIPMENT PTY LTD				
Drawn By PM	Approved By	Title Regulator FirePro Fire Suppression System	Drawing No	Rev.
Scale No	Date 15-10-19		Reg-2	A

Regulator

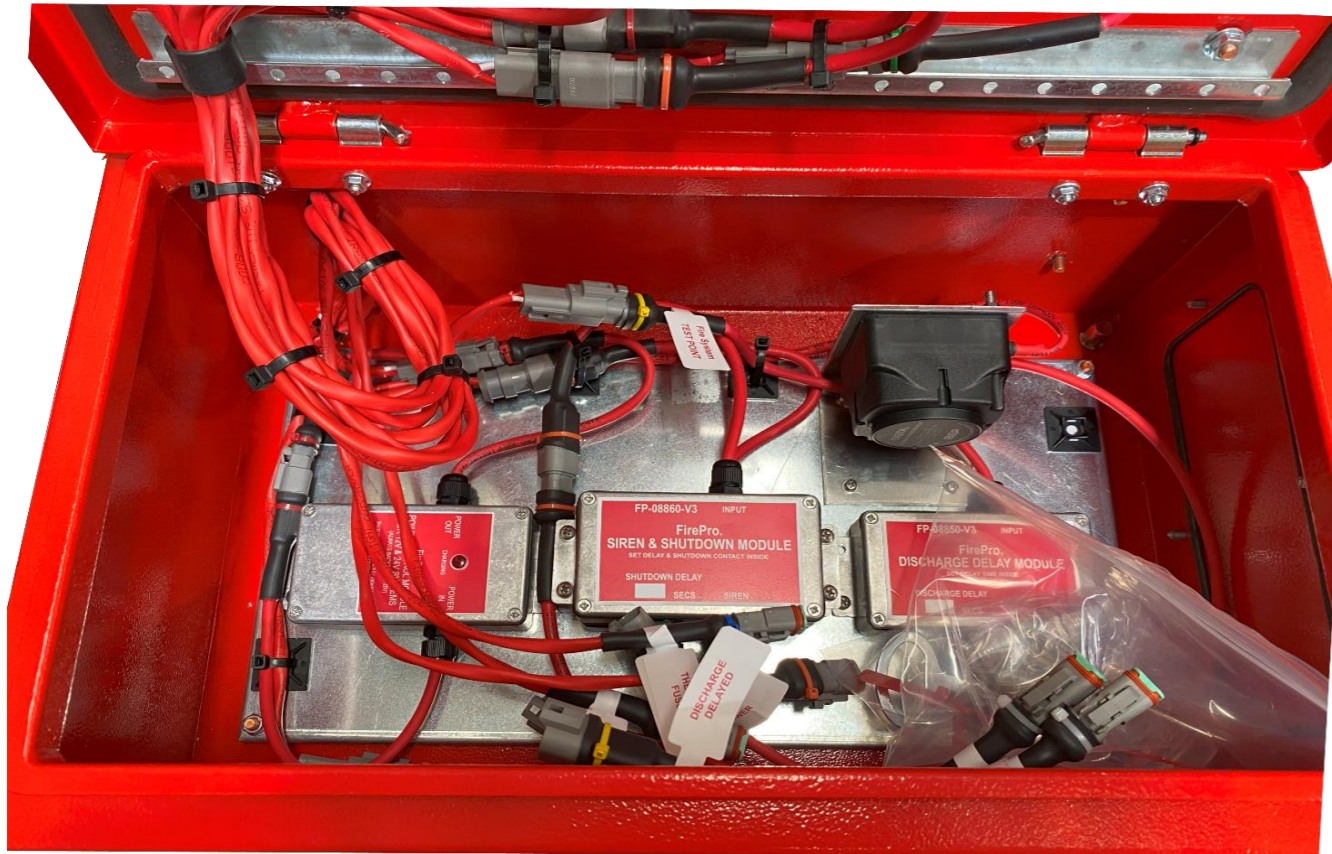

Installed in Enclosure

- 1 FP-08451 Control Panel
- 1 FP-08941 Siren / Strobe
- 1 FP-08872 Battery Backup Module 12-24vDC NiMH
- 1 FP-08850 Discharge Delay Module
- 1 FP-08860 Shutdown Module - to suit 8451
- 1 FP-08879 Digital Volateg Sensitive Relay
- 1 FirePro System Test Point



Electrical Enclosure 500H x 300W x 200D IP66 Red

Features and Specifications

Protection: IP66 IK10, NEMA 4 (Independent accredited test laboratory).
Standard: IEC 62208, IEC/EN/AS60529, (UL508A Optional), RoHS.

Material:

Body: 1.2mm galvanised steel sheet
Gland Plate: 1.5mm galvanised steel sheet
Door: 1.5mm galvanised steel sheet
Device Mounting Plate: 1.5mm galvanised steel sheet
Seal: Polyurethane

Enclosure Door:

1.5mm gal steel with removable hinges. 110° opening. Cable rails, an M6 earth stud.













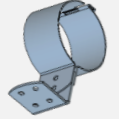









Surface Treatment:

UL epoxy polyester powder-coated. 80-120 micron average thickness. R13 Signal Red.

FIRE SAFETY EQUIPMENT PTY LTD				
Drawn By PM	Approved By	Title Regulator	Drawing No Reg-3	Rev. A
Scale No	Date 15-10-19	FirePro Fire Suppression System		

Regulator

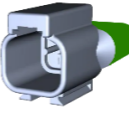
BILL OF MATERIALS

Part No	Qty	Description	Part No	Qty	Description
FP-0500S	2	 500g SS Aerosol Generator	FP-08860	1	 Shutdown Module - to suit 8451
FP-06200	4	 HD SS Bracket to suit 200 - 500	FP-08872	1	 Battery Backup Module 12-24vDC NiMH
FP-08800	2	 FirePro Test Module	FP-14053	4	 External Actuator Switch with Bracket
FP-06920	1	 Dust Seals – to suit FP200-500	FP-14016	1	 Battery cable connection x 3m with 5A Fuse 2 Pin Male Deutsch Plug and Battery Terminal Connectors
FP-08451	1	 Control Panel - FirePro detection and Activation Panel	FP-09500	40	 Cable 2 core 0.75mm Shielded FR x 1m
FP-08918	2	 Splitter Cable	FP-08825	1	 Thermal Fuse with Coupling
FP-08850	1	 Discharge Delay Module	FP-08941	3	 Siren / Strobe with EOL diode Installed
DP-3010	2	 Deutsch Plug – 3 Pin Male, c/w pins and heatshrink to suit	FP-09510-08	1	 Linear Heat Detection 180deg C Cable x 8m with 2 pin Deutsch Plugs fitted
DP-3020	2	 Deutsch Plug – 3 Pin Female, c/w pins and heatshrink to suit	Misc	16	 P-clips to suit FP-09510 LHD
DP-2010	4	 Deutsch Plug – 2 Pin Male, c/w pins and heatshrink to suit	FP-08961	2	 Sign - System Warning Vinyl - Vehicle
DP-2020	4	 Deutsch Plug – 2 Pin Female, c/w pins and heatshrink to suit	FP-08950	2	 End of Line Resistor
FP-08879	1	 Digital Volateg Sensitive Relay			

FIRE SAFETY EQUIPMENT PTY LTD				
Drawn By	Approved By	Title	Regulator	Drawing No
PM			FirePro Fire Suppression System	Reg-BOM
Scale	Date			Rev.
No	15-10-19			A