

Contents

1	Introduction	2
2	Components List	3
3	Design Considerations	4
4	Installation of FirePro Generators	7
5	Connection of Multiple FirePro Generators	8
6	Installation	9
7	Wiring Diagram	11
8	Programming	12
9	Control Panel Indicators & Operation	12
10	Commissioning and Test Procedure	14
11	Servicing and Maintenance	16
12	Troubleshooting	17
13	RFI Environments	18
14	Safety Data Sheet (SDS) - FirePro	18
15	Vehicle and Mobile Plant Installation Notes (AS5062)	19
16	Specifications	20



1 Introduction

1.1 General Information

The FirePro FP-08451 Fire Control Panel is a combined detection and extinguishant system is compliant for vehicle and mobile plant installations (AS5062).

The FIP (fire indicator panel) incorporates:

- 2x Detection circuits;
- 1x Extinguishing Discharge circuit;
- 1x Siren/Strobe circuit;
- 1x Agent Release Notification circuit;
- Programmable Activation (automatic and/or manual);
- Fault Monitoring system;
- Isolation Function.

How Does it Work

All **FirePro** Fire Extinguishing Aerosol Generators use the latest generation FPC solid compound. Upon activation, the solid compound is transformed into a rapidly expanding, highly efficient gas, based on Potassium salts. It does not deplete oxygen levels. **Its built-in fail-safe activation system** ensures operation of the generators when required, even if everything else fails. The FirePro Aerosol Generators have a certified life of 15 years, with minimal maintenance required.

Ozone Depletion Potential (O.D.P.) = 0

Atmospheric Life Time (A.L.T.) = 0

Global Warming Potential (G.W.P.) = 0

Non-corrosive & Non-toxic

1.2 In Case of Fire

If a fire occurs, equipment operators should do the following:

1. Detection will initiate an alarm condition on the FirePro System
2. The siren/strobe will operate and if shutdown relays have been installed, equipment shutdown will be initiated.
3. Evacuate all personnel from the risk area and alert the Fire Brigade.
4. Close all hatches and openings, and shutdown engines and any extraction fans or vents.
5. **Manual Activation:** Press and hold both mode switches continuously for 5 seconds to activate the system.
6. **Automatic Activation:** The control panel will automatically begin the activation sequence when fire has been detected on Circuit 1 Alarm.
7. Keep the FirePro suppression gas within the risk until the fire is extinguished and not able to re-ignite.
8. Do not start engine or fans until the fire is extinguished. Operating the exhaust fans will enable the gas to escape the risk area and could allow the fire to re-ignite.
9. Do not enter the risk until it has been rendered safe.
10. Recommended clean up after discharge is with soapy water or cleaning agent based on citric acid.
11. Following a discharge, replace all installed FirePro Generators and Thermal Fuse Couplings.

2 Components List

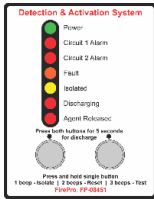

FP-CP-08451
Fire Control Panel
Detection and extinguishant control system

- 2x DP-3000 Deutsch Plug 3 Pin M/F, c/w heatshrink
- 4x DP-2000 Deutsch Plug 3 Pin M/F, c/w heatshrink
- 2x FP-08950 End-of-line Plug 27kΩ ½W (Detection)
- 1x End-of-line Diode 1N4004 (Siren/Strobe)
- 1x End-of-Line Resistor 3k3Ω ½W (Discharge)
- 1x Operator's Manual

Agent Release Circuit Siren / Strobe Circuit



FP-08825
Thermal Fuse Coupling
See 3.2 Agent Released



FP-08940
Siren/Strobe

Discharge Circuit



FirePro Aerosol Generator
100g – 500g Unit.
Constructed from Stainless Steel.
Comes with installed Deutsch Plug for easy install



FP-6200
Heavy Duty Bracket 316 SS.
Suits FP-100, 200, 500 FirePro Aerosol Generators.



FirePro Aerosol Generator
1200g – 5700g Unit.
Constructed from Stainless Steel.
Comes with installed Deutsch Plug for easy install.



FP-6100
Heavy Duty Bracket 316 SS.
Suits FP-1200, 2000, 3000 5700 FirePro Aerosol Generators.

Detection Circuit (Circuit 1 Alarm & Circuit 2 Alarm)



FP-08920
Marine Grade Thermal Detector 60°C Fixed. Other temperatures available on request.



FP-14053
Manual Actuator
Internal OR External



FP-9510
Linear Heat Detection Cable 182° C
Supplied in Cut Lengths with Deutsch Plugs for easy install. Lengths: 1,2,4,6 & 8m

Installation Components Service Components



FP-09500
2 Hour Fire Rated Shielded Cable.



FP-08960
Signage for the System. A sheet of different size labels.



FP-08919
Wiring loom and Splitter Cable for installation of multiple FirePro generators.



FP-08800
FirePro Simulator – for Testing & Commissioning.

Additional Modules



FP-08850
Discharge Delay Module
Allows additional FirePro generators to be discharged



FP-08860
Shutdown Relay Module
Provides facility for equipment shutdown



FP-08870/8871/8872
Power Control Module
Provides back up power for control panel.



FP-08879
Voltage Sensitive Relay

3 Design Considerations

3.1 Power Supply Input

The FP-08451 Fire Control Panel provide a single power supply input that is compatible with 12 / 24vDC. The main power supply should be connected directly to a battery or power source, not through a distribution board. The main power **must not** be interrupted if the vehicle/equipment is powered down. The FirePro Battery Lead (P/N FP-14016) may be used to connect power to the control panel. If a secondary power supply is required for an installation, a Power Control Module will be required.

3.2 Agent Released Input

The Agent Released input provides an indicator to the operator to notify if the suppression system has been activated. For the indicator to operate, the FP-08825 Thermal Fuse Coupling must be used. Thermal Fuse Couplings are single use only. If the suppression system has operated, the thermal fuse coupling must be replaced. If the Agent Release output is not used, the circuit must be bridged out and sealed using the supplied deutsch plugs.

3.3 Siren/Strobe Output

The recommended siren/strobe is the Banshee Sounder-Strobe. In a typical install, the maximum number of supported sirens/strobes that can be installed is 5. When installed, Siren/Strobes are to be clearly visible and audible at all points around the risk area.

The siren/strobe output is a monitored circuit. The supplied end-of-line diode (1N4004) must be installed on the last siren/strobe in the circuit, otherwise the fire control panel will display a fault. If a siren/strobe is not used, the supplied end-of-line diode (1N4004) must be connected to the siren output using the supplied Deutsch plugs.

3.4 Discharge Output

The maximum number of FirePro generators able to be discharged by the FP-08451 Fire Control Panel is limited by the voltage of the main power supply. That is:

Voltage 12vDC Max = 2 Units	Voltage 24vDC Max = 4 Units
------------------------------------	------------------------------------

If a risk area requires a greater number of FirePro generators, the FP-08850 Discharge Delay module must be used. The module will discharge generators in multiples up to the maximum as above.

If the number of FirePro generators connected to each output is greater than the maximum, the fire system will not operate.

When multiple FirePro generators are connected to a single output, they **must** be connected using the FP-08919 Splitter Lead. If a suppression system is not used, the supplied end-of-line resistor (3k3Ω) must be connected to the Discharge output using the supplied deutsch plugs.

3.5 Circuit 1 Alarm Output

The Circuit 1 Alarm Output is a zoned detection circuit capable of operating up to 30 conventional detectors, 100 metres of linear heat detection cable or 30 manual actuators. The Circuit 1 Alarm Output can be programmed for detection and alarm, or for automatic discharge if an alarm is detected on this circuit. The end-of-line resistor (22k or 27kΩ) must be installed on the last detector or manual actuator in the circuit, or the fire control panel will display a fault. The end-of-line plug (marked green) must be connected.

3.6 Circuit 2 Alarm Output

The Circuit 2 Alarm Output is a zoned detection circuit capable of operating up to 30 conventional detectors, 100 metres of linear heat detection cable or 30 manual actuators. The Circuit 2 Alarm Output is a detection and alarm circuit only. When in alarm condition the siren/strobe will operate, however the suppression system will not discharge until manually operated. The end-of-line resistor (22kΩ) must be installed on the last detector or manual actuator in the circuit, or the fire control panel will display a fault. The end-of-line plug (marked green) must be connected.

3.7 Agent Release Notification – Thermal Fuse

The thermal fuse is required by AS-5062 as an indicator that the system has activated. The thermal fuse should be mounted on the most convenient – or closet FirePro unit to the Control Panel. Only one thermal fuse is required in each system. The fuse is mounted in a stainless steel enclosure, and this is rated to IP65. It is designed for use at temperatures between -5°C (+/- 3) and +40°C (+/- 2) and with a maximum relative humidity of 95%. The fuse is a means of indicating to the FIP that the system has operated. It has no ability to activate the system.



SINGLE USE ONLY – CANNOT BE RESET

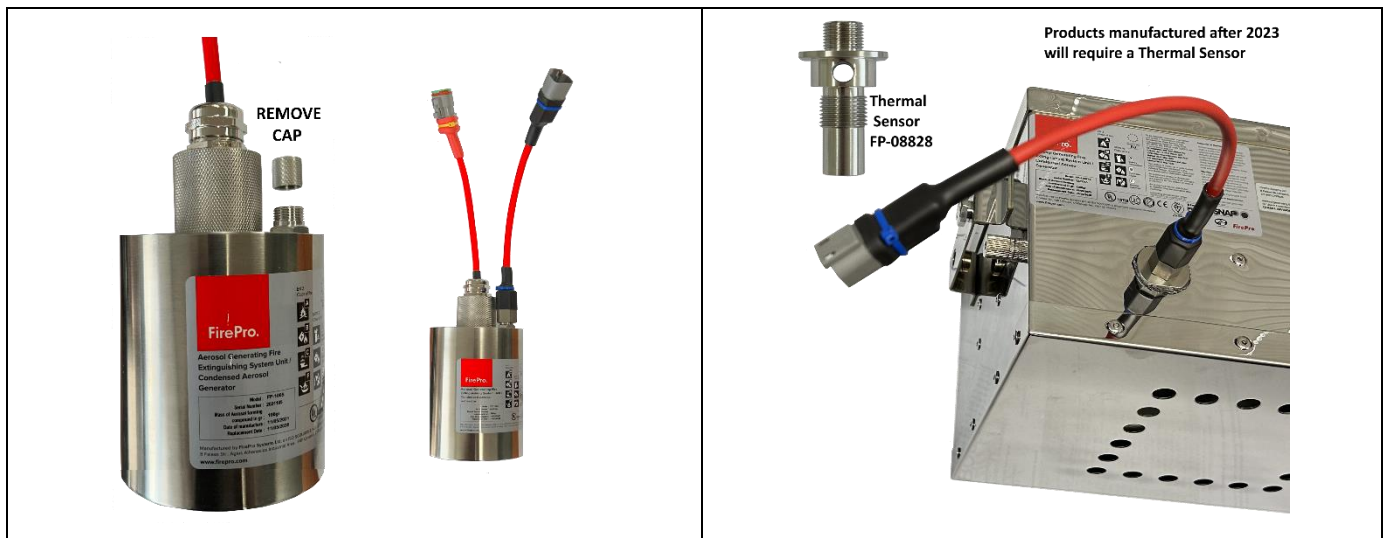

3.8 Mounting

For correct installation, the Fire Control Panel must be mounted by four bolts or screws through the mounting holes in the flange on both sides of the Module. **No penetrations are to be made through the casing of the panel.**

The Fire Control Panel enclosure is rated IP65, so should be installed in a convenient location, away from where it may be affected by large amounts of water.

It is necessary to complete all wiring and any programming of the detection mode prior to mounting the panel.

Dimensions and relevant clearances for installing the FP-08451 Control Panel are below. A Dash Mount Bracket (P/N FP-08451B) is also available and may be used if the minimum clearances cannot be met.

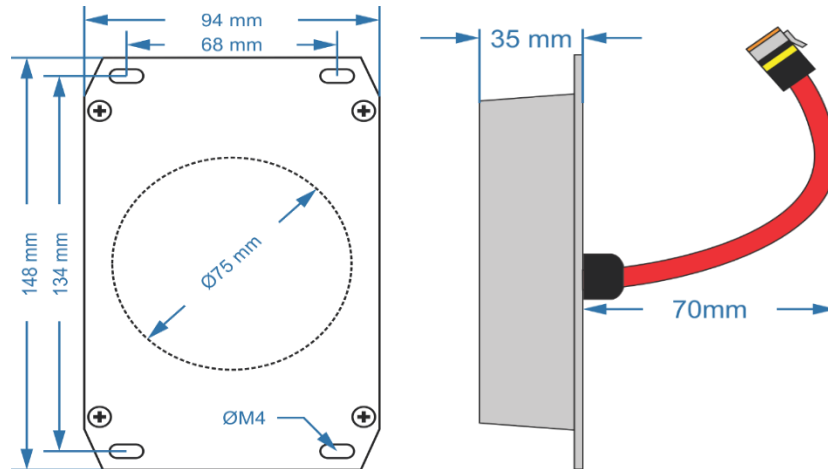

3.9 System Test Point

Due to regular testing requirements, it is good practice to install a System Testing point. This is a break in the activation cable from the control panel. Attach Deutsch plugs which allow the FirePro Simulator to be connected. Locate where it is easy to access and be signed as **"FirePro System Test Point"**. **The benefit is that all FirePro units in the system will be disconnected for testing, so the chance of accidental activation during testing is reduced.** It creates a process which is easy to follow for anyone working on the system.

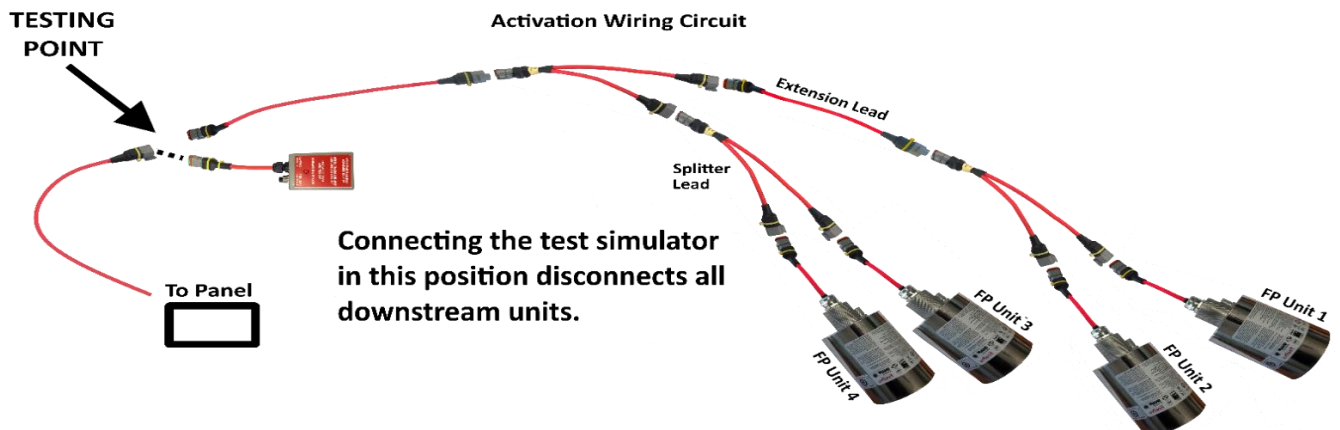

3.10 Cabling Requirements

Cable Requirements - All cabling in the FirePro Installation MUST be done using 0.75mm shielded Fire Rated Cable. Cables are colour coded for easy identification.

Colour	Circuit
Red	Power Supply
Yellow	Activation
Yellow with black stripe	Activation Delayed
Green	Detection 1
Green with black stripe	Detection 2
Blue	Discharge Advice
Orange	Siren/Strobe
White	Relay Output

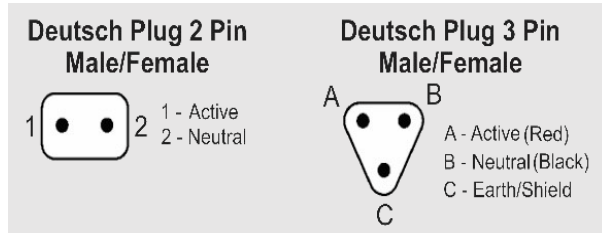

Deutsch Plugs must be used to ensure water-proof connections are made throughout the installation.

4 Installation of FirePro Generators

FirePro Condensed Aerosol Fire Extinguishing System Arrangement.

- FirePro units and system components installed to allow inspection and maintenance.
- Locate FirePro units where they are not exposed to mechanical damage, exposed to chemicals, or weather conditions, that may render them inoperative. Protective provisions shall be adopted, if necessary.
- FirePro units shall be securely installed. Use heavy duty brackets where necessary. Brackets should be capable of handling the risk environment, including vibration.

FirePro units must be installed **at NOT less than the minimum safe distances** as specified in the design calculations.

Means for prompt rescue of any trapped personnel shall be provided, including:

- Adequate aisle ways/routes of exit.
- Alarms – audible and visual, that operate immediately on detection of the fire.
- Signs in accordance with relevant standards for the installation.

System components shall be positioned to the minimum clearances from energized electrical parts as per: AS 4487 and AS 3000.

Handling and Storage - when handling the Condensed Aerosol Generators do not:

- Disassemble the unit
- Carry out any welding work in the vicinity of the fire extinguishing system components.
- Exert force or impact which creates physical or mechanical damage to the casing.

STORAGE and OPERATIONAL CONDITIONS

- Temperature: -54 and +54°C
- Humidity: maximum 98% RH
- Service life: 15 years (date of manufacture appears on each generator)

Positioning



CORRECT

FP Units directing the aerosol stream away from opening

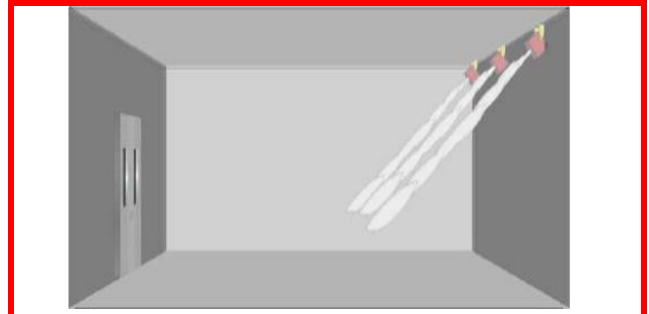

INCORRECT

FP units are directing the stream towards the opening.

5 Connection of Multiple FirePro Generators

Where multiple FirePro Generators are installed, connect using the FP-08919 Splitter Lead.

Splitter Leads can be installed at any point on the activation. For ease of install, servicing and efficient field wiring, Splitter Leads should be installed in areas easy to access and minimise extension leads.



The supply voltage of any system will determine the no of FirePro units which can be used

12vDC

Max = 2 FP Units

24vDC

Max = 4 FP Units

Where additional units are required in the system use **Discharge Delay Module(s)**.

Connection of 2 FirePro Units

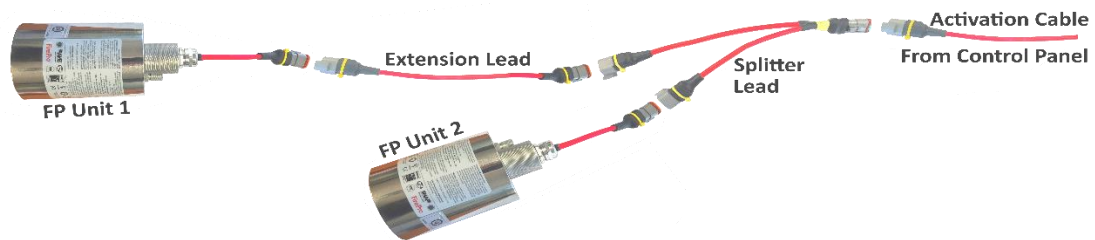

Connection of 4 FirePro Units

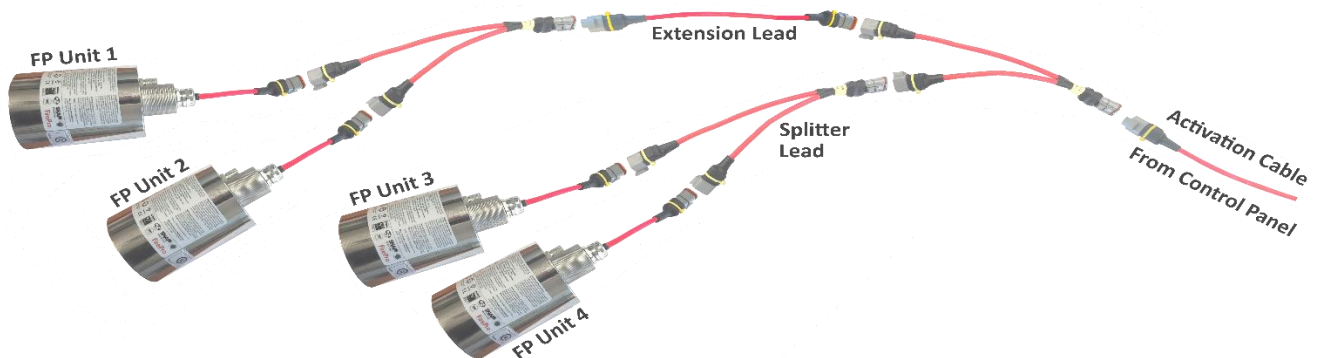

6 Installation

It is recommended that one circuit is installed and connected at a time to isolate the cause of any faults that may occur during installation. The supplied End-of-line plugs and Test Module may be used to keep the control panel out of a fault condition.

- Power:** When panel has been mounted in a suitable location, connect main supply power using a FP-14016 Battery Lead to the power input (marked red).

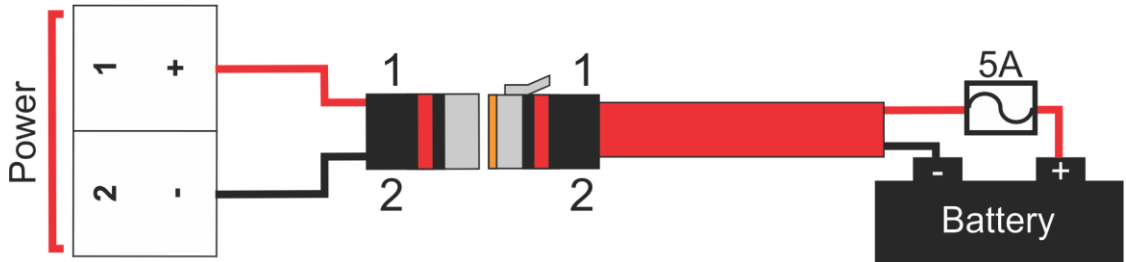

- Agent Released Circuit:** The Thermal Fuse Coupling (P/N FP-08825) should be screwed into the thermal port on one of the installed FirePro generators and connected to the control panel.

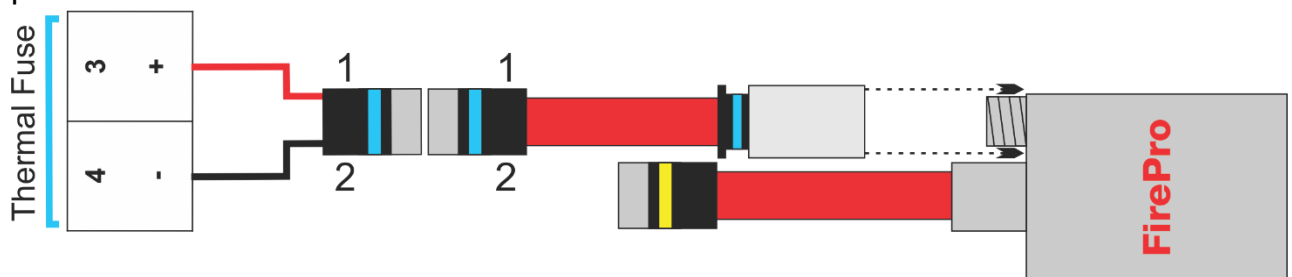

- Siren/Strobe Circuit:** Mount the siren/strobe (P/N FP-08940) in a location where it is visible and audible in all points with the risk area and connect to the "Siren" output on the module (marked orange). If more than one siren/strobe is being installed, they are to be connected using the secondary positive/negative terminals in the sounder.

The supplied end-of-line diode should be installed in the secondary positive/negative terminals of the last siren/strobe in the circuit. The diode is polarised, so the positive lead of the diode (marked with a grey band) should be terminated in the positive terminal of the siren/strobe, otherwise a fault will occur on the fire control panel.

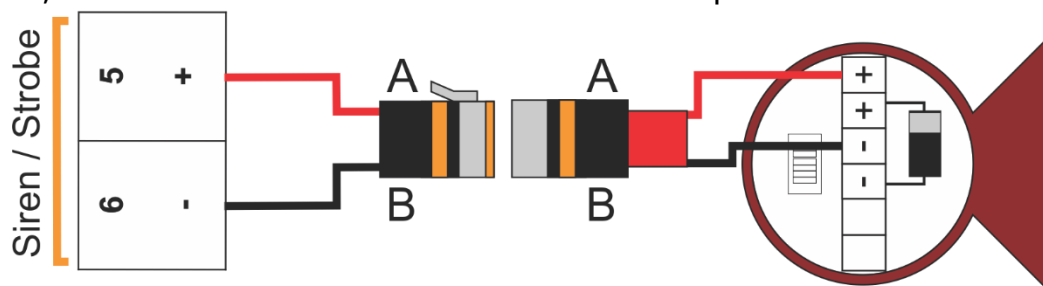

- Circuit 1 Alarm Circuit:** This circuit can be programmed for **ALARM ONLY** (operate siren/strobe) or **AUTOMATIC DISCHARGE** (discharges suppression system and operates siren/strobe). If detection is not used, the supplied end-of-line plugs (marked green) must be connected to the Circuit 1 Alarm output.

Manual Actuator (P/N FP-14053) can be connected together in quantities up to 30. If a manual actuator is being used for remote activation, it **must** be installed on Circuit 1 Alarm. The supplied end-of-line plugs (marked green) must be connected to the last manual actuator in the circuit.

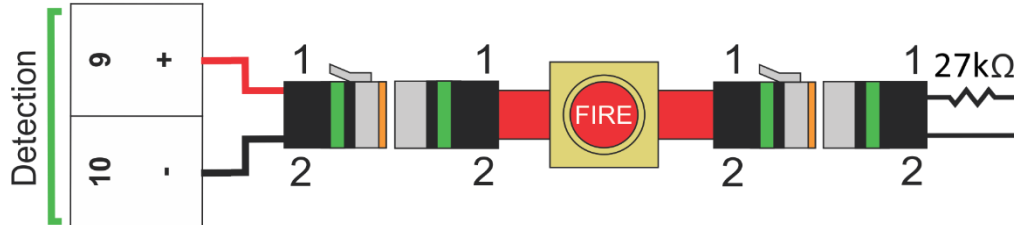

Linear Heat Detection: Linear Heat Detection can be installed in cut lengths with Deutsch plugs fitted. P-Clips must be installed at intervals of 50cm maximum to support the cable. The supplied End-of-line resistor is mounted in the Deutsch plug.

Conventional Detector (Thermal / Smoke): Conventional Detector (P/N FP-08920 Thermal / FP-94140 Smoke) can be connected together in quantities up to 30. A End-of-line resistor must be installed in the last detector in the circuit.

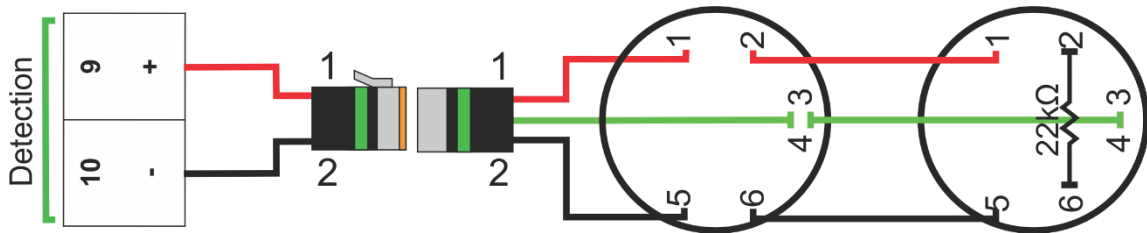

Detection Not Used: If detection is not used, the supplied end-of-line plugs (marked green) must be connected to the Circuit 1 Alarm output.

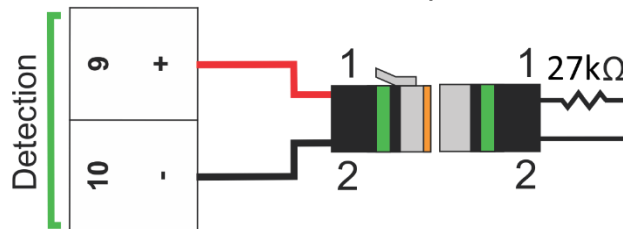

5. **Circuit 2 Alarm Circuit:** This circuit is **ALARM ONLY** and will only operate the siren/strobe. Connections for detection and manual actuators are the same as Circuit 1 Alarm. This is a monitored circuit so end-of-line plugs (marked green) must be connected.
6. **Discharge Circuit:** This circuit should remain disconnected until all other circuits are connected. The control panel **must not** be in an alarm/fault condition when the FirePro generators are connected, as this may cause an accidental discharge. A FirePro Test Module (P/N FP-08800) should be connected to take the control panel out of fault condition and for any commissioning.

Connecting FirePro Generators: If a single FirePro Generator is being installed, it can be

connected directly to the Discharge output on the control panel.

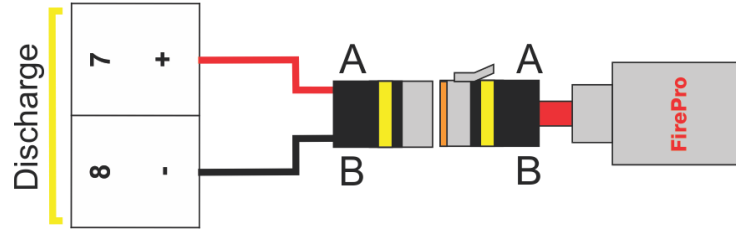

Discharge Not Used: If the discharge circuit is not used, the supplied end-of-line resistor (3k3Ω) must be connected to the Discharge output using the supplied deutsch plugs.

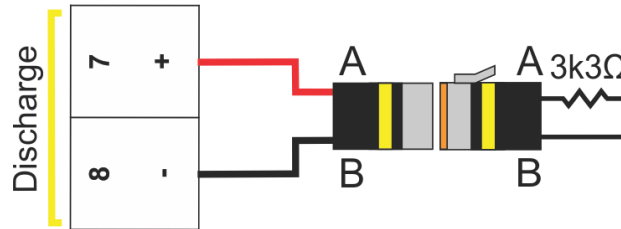

7 Wiring Diagram

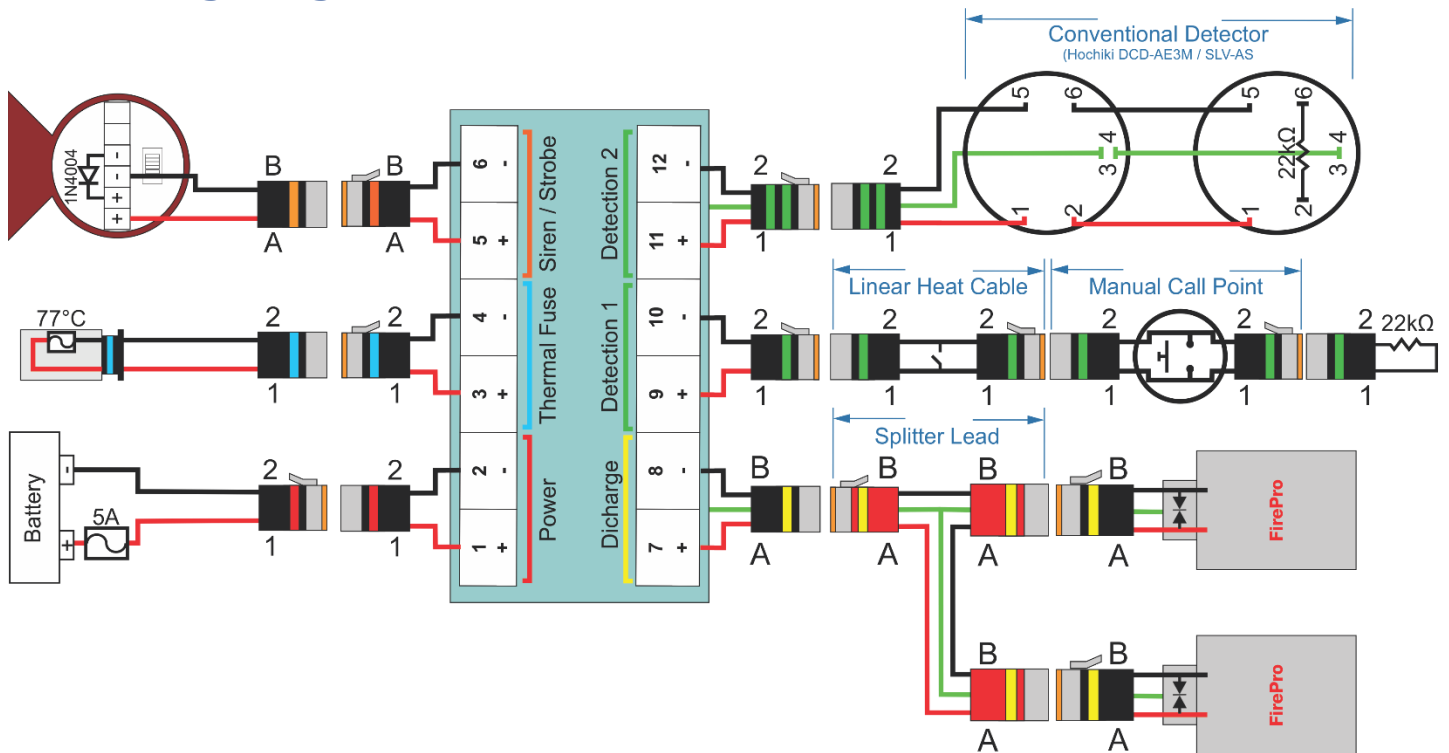

8 Programming

The FP-08451 Control Panel provides several programming options, allowing it to be adapted to site conditions. The 2-way DIP switches inside the panel next to the terminal block allow one of 4 modes to be selected. To access the DIP switches, open the panel enclosure.

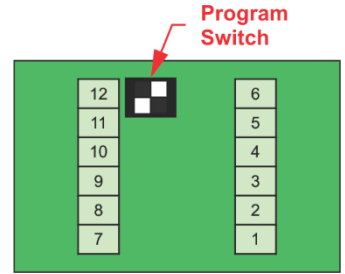

Switch 1	Mode	Switch 2	Mode
	Standard Discharge Power Applied for 2 seconds DEFAULT		Manual Discharge Detectors operate siren/strobe only
	Extended Discharge Power applied for 240 seconds		Automatic Discharge Detection on Circuit 1 Alarm will discharge system DEFAULT

Note: All programmed settings should be recorded in the logbook.

Note: If a Discharge Delay Module (P/N FP-08850) is installed, panel **must** be programmed for extended discharge.

9 Control Panel Indicators & Operation

9.1 LED Indicators

The FP-08451 Control Panel uses LED indicators to notify the operator of the condition of the control panel and each of the monitored circuits. If an LED is illuminated, it indicates the following:

Circuit	LED	Condition
Power	Green	Power supply is available
Circuit 1 Alarm	Red	System is in alarm condition
Circuit 2 Alarm	Red	System is in alarm condition
Fault	Yellow	System is in fault condition and needs servicing
Isolated	Yellow	System has been isolated using buttons on panel
Discharging	Red	System has initiated activation sequence
Agent Released	Red	Agent has been released and needs servicing

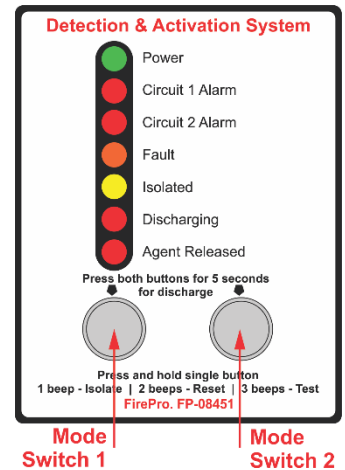

9.2 Isolate Function

To **isolate** the control panel, press and hold Mode Switch 1 until a 1 beep is heard and the "Isolated" LED is illuminated. To **restore** the control panel to normal operation, press Mode Switch 1 and ensure the "Isolated" LED turns off.

Isolating disables automatic activation. Manual Activation will remain operational.

When isolated, the control panel continues to monitor for alarm and fault, and show the alarm and fault indications, but will not operate the siren and the automatic discharge. When

isolated, any change in the detector status, will cause the panel sounder to operate for 1 second as an alert of the status change, but the panel will remain isolated. The isolate function will also silence the siren/strobe and the internal sounder but will not cancel the alarm or fault indication.

9.3 Reset Function

To reset the control panel, press and hold Mode Switch 1 until 2 beeps are heard. Following a reset, the control panel will automatically isolate. To restore the control panel to normal operation, press Mode Switch 1 and ensure the "Isolated" LED turns off. **Note:** The control panel **cannot** be reset if the activation sequence has been initiated. When the "Discharging" LED is no longer illuminated, the reset function will become available again.

9.4 Test Function

The control panel includes a test function, enabling the operator to ensure that the control panel is functioning correctly. To operate the test function, press and hold Mode Switch 1 until 3 beeps are heard. The test function will illuminate all LEDs on the control panel and operate the internal sounder and any external siren/strobes for 2 seconds, and then return the control panel to normal operation. The test function does not activate the suppression system. **Note:** If any LEDs or siren/strobes do not operate, contact your supplier.

9.5 Discharging the Fire System

To manually discharge the fire system, press and hold both Mode Switch 1 and Mode Switch 2 continuously for 5 seconds. This will immediately operate any installed siren/strobes and any shutdown relays, to warn any occupants. Manually discharging the fire system should only be performed during commissioning/servicing when the system has been appropriately isolated, or in case of fire.

9.6 Alarm Silence

To silence the internal sounder and any installed siren/strobes that have operated due to an alarm condition, press and hold Mode Switch 1 until a 1 beep is heard and the "Isolated" LED is illuminated. This will also override any installed shutdown relays and allow for operation of the equipment. **Note:** Equipment should not be operated until it has been rendered safe by the appropriate authority. The control panel will remain in an alarm/fault condition until serviced and reset.

10 Commissioning and Test Procedure

Commissioning should be performed when the fire control panel is not in an alarm/fault condition. **Note:** No personnel should be in the risk area until the fire system is fully isolated.

To ensure that the FirePro system will operate as designed, it should be inspected and serviced every 6 months, and yearly, in accordance with AS1851 and AS5062.

Six Monthly Test Procedure:

- **Isolate the control panel** and disconnect the any installed FirePro aerosol generators. This will generate a fault on the fire control panel.
- **Connect FP-08800 Test Module(s)** to the "Discharge" output to the panel (marked yellow). Turn off the Isolate function. The Test Module should remain installed throughout the test procedure.

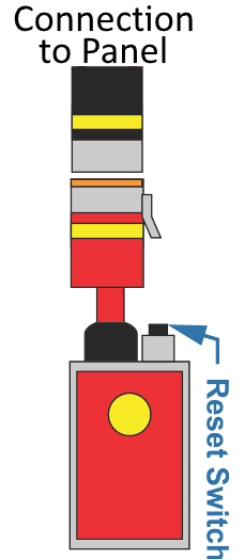

Testing of 4 FirePro Units

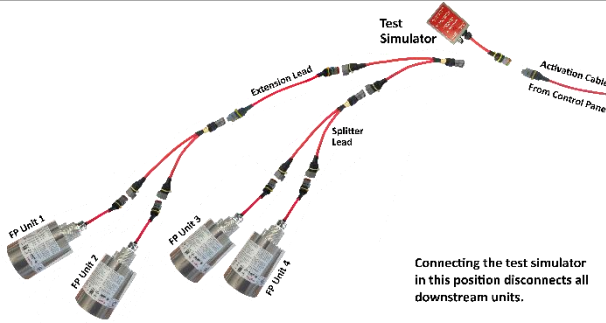

Testing of 2 FirePro Units

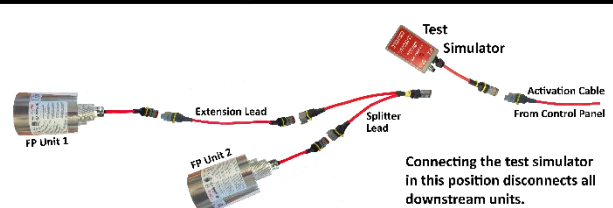

Alternate testing of 4 FirePro Units

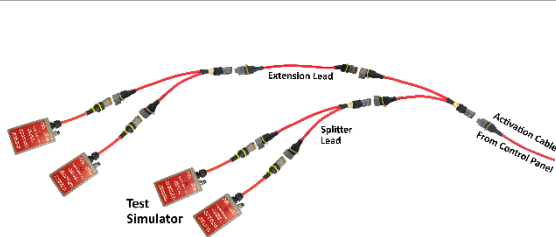

Alternate testing of 2 FirePro Units

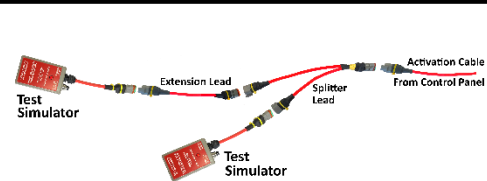

- **Control Panel and components:**

- Clean and remove dirt, grease or foreign material. Replace any parts that appear damaged or have been painted.
- Check all indicators are in normal position.

- **FirePro Aerosol Generators:**

- Inspect FirePro generators to ensure they are in good condition.
- Check mounting brackets are in good condition and secure.
- Check Dust Covers are in good condition – replace as necessary.
- Check FirePro Units are at predetermined aiming points.

- **Electrical System Inspection:**
 - Check Manual Actuators are secure, clean, undamaged.
 - Check that anti-tamper seals/pull pins are in place and secure.
 - Check all wiring, connection and supports are in intact, undamaged and in correct position.
- **Labels:**
 - Check manual release, system warning and instruction labels are in place and legible.
- **Test the fault monitoring** system by disconnecting and reconnecting all connected detection devices and the siren strobe circuit one at a time. Ensure the "Fault" LED indicator illuminates and the internal sounder is heard each time a circuit is disconnected.
- **Discharge Testing from Control Panel:**
 - Perform a manual discharge test by pressing and holding both mode switches on the panel continuously for 5 seconds.
 - Following activation, ensure the Test Module Red LED has operated.
 - Isolate the panel to silence alarm. Panel should now display a fault.
 - Reset Test Module. Panel should no longer be in fault condition.
 - Turn off the Isolate function.
- **Discharge Testing from External Devices:** Each detection and manual actuator device connected to must be tested individually.
 - Perform an automatic discharge test by activating the detectors or manual actuators.
 - Following the activation sequence ensure the Test Module Red LED has operated.
 - Isolate the panel to silence the alarm. The control panel should now display a fault.
 - Reset the Test Module.
 - Reset the control panel by pressing and holding a single mode switch until 2 beeps are heard. The control panel should no longer be in alarm/fault condition.
- **System control and indicating equipment.**
 - During discharge test, ensure operation of all installed siren/strobe(s).
 - During discharge test, ensure operation of all installed shutdown relays. This must shutdown any equipment specified in the risk assessment.
 - Test backup battery capacity. Replace every backup battery every 2 years.
- Disconnect the FP-08800 Test Module and reconnect all FirePro aerosol generators.
- Turn off the Isolation function. System is now operational.

Additional requirements for Commissioning of a System after Install or Discharge

- **Design Survey** - check against the baseline data, for alterations, changes in use or operating environment, or other factors that could affect the performance of the fire protection system. (Annual)
- **Risk Assessment** – required to be prepared and reviewed every 5 years or after any incident. Review document to ensure system compliance. Check if document is current.

11 Servicing and Maintenance

Inspection and servicing of the installed fire system should occur in accordance with the relevant Australian Standards (i.e. AS1851 or AS5062). Any alterations to the risk area should be recorded and where necessary the risk assessment, design calculation and installed components must be revised to reflect the new operating conditions.

A logbook must be kept, recording all the relevant information from the installation and servicing. The logbook must contain the following:

Content of logbook:

- General details
- Devices used
- Date and outcome each inspection
- Risk Assessment

Appendices of Logbook:

- Schematic diagrams
- Photos of the original Installation
- Programming of the control panel
- Inspection reports

11.1 Daily Service Schedule

A daily inspection should be performed by the operator prior to operation of the equipment. If anything does not appear normal, the equipment should not be operated and the fire service provider alerted. The Daily Inspection should include:

- Visual inspection of the control panel and installed components. These should be accessible and free from debris, rust, or electrical faults.
- Visual inspection of the control panel to ensure normal functioning. When functioning normally the only indicator illuminated should be the "Power" indicator (green).
- Visual inspection of anti-tamper seals and travel pins, to ensure they are in place.

11.2 Semi-annual / Annual Service Schedule

Semi-annual and Annual servicing and maintenance **are to be undertaken only by accredited service technicians.** Any misuse of the FIP may result in an accidental discharge of the suppression system and is not covered by warranty.

Servicing should include a visual inspection of all the installed components to ensure they are in good condition, and that the relevant stream lengths and thermal clearances are observed as per the original design calculation and risk assessment.

Operation of the fire system should be tested as outlined in 8. Commissioning.

12 Troubleshooting

The FP-08451 Control Panel provides a comprehensive fault monitoring system that will detect any open-circuit in the Circuit 1 Alarm Output, Circuit 2 Alarm Output, Siren/Strobe Output, Discharge Output and Agent Released Input and any malfunctions of the control panel's internal components.

When in a fault condition, the control panel will operate the "Fault" LED indicator and operate the internal sounder. The control panel uses a coded sequence to indicate the type circuit to the operator. **Note:** To diagnose if a fault is internal or external, attempt to isolate the panel. If the control panel can be isolated, the fault is external. (see 9.2 Isolating the Control Panel).

12.1 Fault Indicators

A fault will be indicated if any monitored circuit connected to the panel is not complete. This could be caused by the devices connected or the wiring to each device. This will display as:

Internal Sounder	Fault LED	Fault
1 beep	On	Circuit 1 Alarm
2 beeps	On	Circuit 2 Alarm
3 beeps	On	Discharge Circuit
4 beeps	On	Siren/Strobe Circuit – Version 4 Panel Only

This will require inspection and testing of connections and installed components. End-of-line plugs should be plugged directly into the panel, to return it normal condition, and then used to systematically check along the effected circuit(s). If the fault persists, contact your supplier.

12.2 Panel is Unresponsive

If the panel has become unresponsive, check the incoming power supply. Panel will operate down to approx. 9vDC. If incoming voltage is above this contact supplier.

12.3 Internal Faults

An internal fault cannot be isolated and will display as:

Internal Sounder	Fault LED	Fault
Continuous, steady beep	On	Internal 5vDC Supply OR Watch Dog Circuit
Continuous, pulsing beep	On	Internal Microprocessor

Internal faults can be rectified by powering down the panel and powering up again. This will reset the system to normal conditions. If the fault persists, contact your supplier.

12.4 Agent Released Fault



Refer to 3.2 Agent Released Input. If the Agent Released LED is illuminated, this indicates a fault on the Agent Release input. Typical causes are that the thermal fuse coupling has operated or has been disconnected. To test if the thermal fuse coupling has operated, check with a multi-meter for a closed circuit. Thermal Fuse couplings are single use only. If the thermal fuse coupling has operated, it must be replaced (P/N FP-08825). If the thermal fuse coupling is functioning normally and the fault persists, contact your supplier.

13 RFI Environments

The control panel's circuit arrangement provides protection designed for the effects of electromagnetic emissions and prevent accidental discharges of the system. Shielded, fire rated cable (FP-09500) is **MUST** to be used throughout every installation to protect the fire system from electromagnetic emissions. Cables should be installed with appropriate clearances from any cables or equipment that may produce high levels of RF interference.

14 Safety Data Sheet (SDS) - FirePro

This is an **EXTRACT ONLY** from the full SDS. To view the full SDS go to www.chemwatch.com.au.

	<p>HAZARDOUS SUBSTANCE. DANGEROUS GOODS. According to NOHSC Criteria, and ADG Code.</p> <p>CHEMWATCH HAZARD RATINGS</p> <table border="1"> <tr> <td>Flammability</td> <td>Low=1</td> <td>Moderate=2</td> <td>High=3</td> <td>Extreme=4</td> </tr> <tr> <td>Toxicity</td> <td>Low=1</td> <td>Moderate=2</td> <td>High=3</td> <td>Extreme=4</td> </tr> <tr> <td>Body Contact</td> <td>Low=1</td> <td>Moderate=2</td> <td>High=3</td> <td>Extreme=4</td> </tr> <tr> <td>Reactivity</td> <td>Low=1</td> <td>Moderate=2</td> <td>High=3</td> <td>Extreme=4</td> </tr> <tr> <td>Chronic</td> <td>Low=1</td> <td>Moderate=2</td> <td>High=3</td> <td>Extreme=4</td> </tr> </table> <p>SCALE: Min/Nil=0 Low=1 Moderate=2 High=3 Extreme=4</p> <div style="display: flex; justify-content: space-around;">   </div>	Flammability	Low=1	Moderate=2	High=3	Extreme=4	Toxicity	Low=1	Moderate=2	High=3	Extreme=4	Body Contact	Low=1	Moderate=2	High=3	Extreme=4	Reactivity	Low=1	Moderate=2	High=3	Extreme=4	Chronic	Low=1	Moderate=2	High=3	Extreme=4
Flammability	Low=1	Moderate=2	High=3	Extreme=4																						
Toxicity	Low=1	Moderate=2	High=3	Extreme=4																						
Body Contact	Low=1	Moderate=2	High=3	Extreme=4																						
Reactivity	Low=1	Moderate=2	High=3	Extreme=4																						
Chronic	Low=1	Moderate=2	High=3	Extreme=4																						
<p>PRODUCT NAME CELANOVA FIREPRO</p> <p>PRODUCT USE Fire extinguishing agent.</p>																										

POISONS SCHEDULE - None

RISK	SAFETY
------	--------

- Contact with combustible material may cause fire.
- Harmful if swallowed
- Irritating to eyes and skin.
- May cause SENSITISATION by skin contact.
- Harmful to aquatic organisms may cause long- adverse effects in the aquatic environment.
- Cumulative effects may result following exposure
- May produce discomfort of the respiratory. system*
- Possible respiratory sensitiser*.
- May possibly affect fertility* (limited evidence).

- Keep away from combustible material
- Avoid exposure - obtain special instructions before use.
- To clean the floor and all objects contaminated by this material use water and detergent.
- Keep away from food drink and animal feeding stuffs.
- In case of contact with eyes rinse with plenty term of water and contact Doctor or Poisons Information Centre.
- If swallowed **IMMEDIATELY** contact Doctor or. Poisons Information Centre (show this container or label).
- This material and its container must be disposed of as hazardous waste.

FIRST AID MEASURES

SWALLOWED	<ul style="list-style-type: none"> • If swallowed do NOT induce vomiting. • If vomiting occurs, lean patient forward or place on left side (head-down position, if possible) to maintain open airway and prevent aspiration. Observe the patient carefully. • Never give liquid to a person showing signs of being sleepy or with reduced awareness. • Give water to rinse out mouth, then provide liquid slowly and as much as casualty can comfortably drink. • Seek medical advice.
EYE	<ul style="list-style-type: none"> • If this product comes in contact with the eyes: • Wash out immediately with fresh running water. • Ensure complete irrigation of the eye. • Seek medical attention without delay; if pain persists or recurs seek medical attention. • Removal of contact lenses after an eye injury should only be undertaken by skilled personnel.
SKIN	<ul style="list-style-type: none"> • If skin contact occurs: • Immediately remove all contaminated clothing, including footwear. • Flush skin and hair with running water (and soap if available). • Seek medical attention in event of irritation.
INHALED	<ul style="list-style-type: none"> • If dust is inhaled, remove from contaminated area. • Encourage patient to blow nose to ensure clear passage of breathing. • If irritation or discomfort persists, seek medical attention.

15 Vehicle and Mobile Plant Installation Notes (AS5062)

For AS5062 vehicle installations, a risk assessment must be completed all equipment, and the design agreed upon by the installer and operators. The risk assessment should include identification of all fuel and ignition sources, and these must be considered in the system design.

AS 5062 requires:

Automatic Discharge: The system shall be programmed for automatic discharge on alarm unless it is determined by the risk assessment why automatic discharge would be inappropriate.

Equipment Shutdown: As determined by the risk assessment, any equipment that may impede operation of the fire system must be shutdown prior to system discharge. This requires the installation of the FP-08860 Shutdown Relay Module.

Secondary Power Supply: In addition to the power supply requirements as per 3.1 Power Supply Input, AS5062 also requires a secondary power supply capable of operating the fire system for a minimum of 24 hours. This requires the installation of the Power Control Module, or the identification of a secondary power source in the equipment that will not be affected by any failure of the primary power supply.

System Discharge Advice: AS5062 requires independent notification of the suppression system discharged. This requires the installation of the FP-08825 Thermal Fuse Coupling.

Manual Actuation: Should manual actuators must be installed on Circuit 1 Alarm to allow for remote manual activation of the suppression system. This requires the installation of FP-14053 Manual Actuators and Circuit 1 Alarm to be programmed for automatic discharge.

16 Specifications

General	Dimensions	148L x 84W x 35D mm	
	Material	Diecast Aluminium, UV Tolerant	
	Ingress Protection	IP65	
	Operating Temperature	-40 to 85 degrees Celsius	
	Fault Monitoring – External	<ul style="list-style-type: none"> - Circuit 1/2 Alarm – Open/Closed - Siren/Strobe – Open/Closed - Discharge – Open/Closed 	
	Fault Monitoring – Internal	<ul style="list-style-type: none"> - Poly-switch fuse operated - Loss of internal 5V supply - Internal microprocessor malfunction 	
Power Supply Input	Mains Operating Voltage	12-30VDC	
	Mains Operating Current	20mA on 12V	23mA on 24V
	Backup Power	See FP-08870 / 08871 / 08872 manual	
Detection Output Circuit 1 Alarm & Circuit 2 Alarm	No. of Detection Zones	2	
	Operating Voltage	12-30VDC (same as main supply voltage)	
	Detection End-of-line	27kΩ / 22kΩ ½W Resistor	
	Maximum Detectors per Zone	<ul style="list-style-type: none"> - 30 Conventional Detectors - 100m Linear Heat Detection - 30 Manual Actuators 	
	Alarm Threshold	3.6V Fault sensing threshold: 0.53V	
	Compatible Detectors	Hochiki SLV-AS Smoke Detector Hochiki DCD-AE3M Thermal Detector 14053 Manual Actuator 09510 180°C Linear Heat Detection	
Discharge Output	Discharge Output Current	1.5A at 12vDC	1.5A at 24vDC
	Discharge End-of-line	3K3Ω ½W Resistor	
	Max FirePro Units	2 at 12vDC	4 at 24vDC
	Standard Discharge Delay	5 seconds from automatic/manual activation	
	Max Discharge Delay Modules	2 DDM's at 12vDC	4 DDM's at 24vDC
	Max FirePro units using DDM's	6 at 12vDC	20 at 24vDC
Siren/Strobe Output	Siren/Strobe Output Current	Max 0.5A	
	Siren/Strobe Output Protection	0.5A poly-switch resettable fuse	
	Siren/Strobe End-of-line	1N4004 Diode	
	Max Siren/Strobes	5	
	Compatible Siren/Strobes	Banshee Sounder Strobe	
	Max Siren Shutdown Modules	2 at 12vDC	4 at 24vDC
Agent Released Input	Input Type	Thermal Switch, NC, Latching, Non-resettable	
	Operation	Thermal Event >80°C	

BANSHEE multi-tone sounder/strobe - suitable for internal or external locations.



Specifications		
Voltage:	9 – 30vDC	
Current:	12v - Max 60mA	24v - Max 39mA
Sound Output:	101dB(A)	
Beacon:	0.7j	
Flash Rate:	60/min (1Hz)	
Temperature:	-20 C to +55 C	
IP Rating:	FP-08940 – IP 45	FP-08941 – IP 66