

Y - 1260 with XC4004 Controller

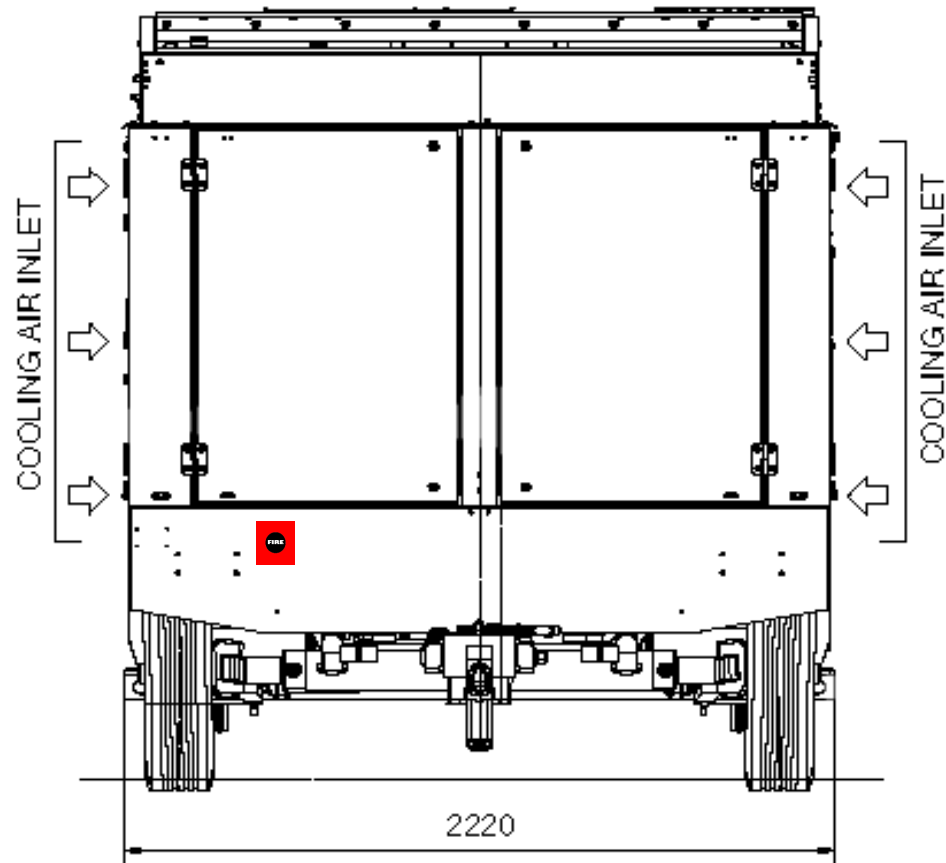

FRONT MOUNTED VIEW

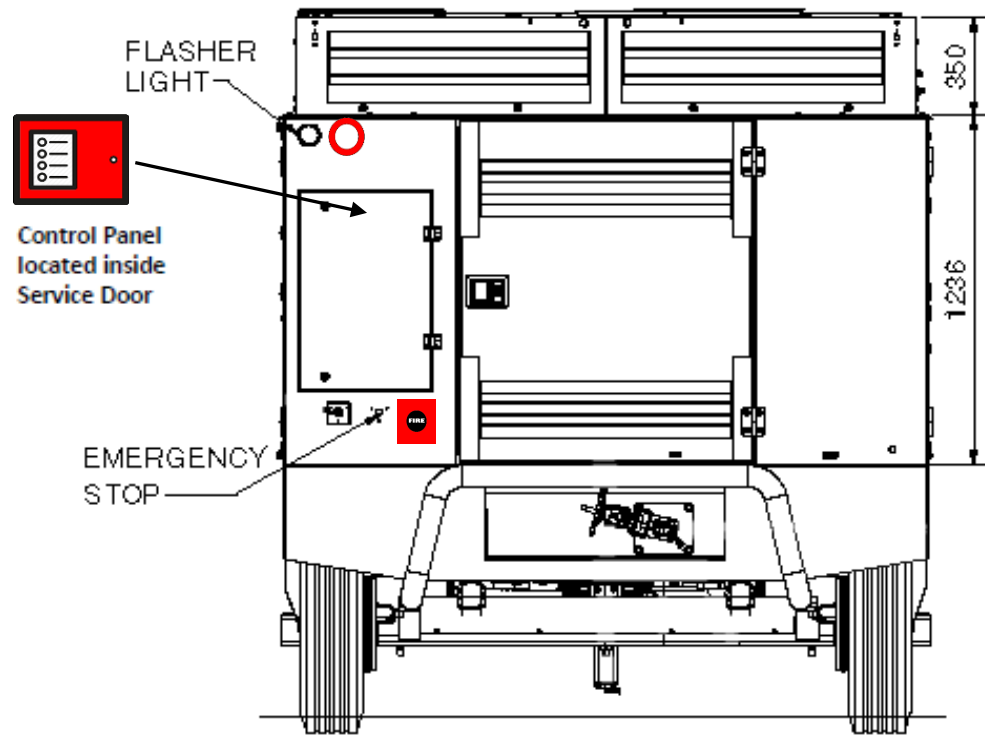

REAR MOUNTED VIEW

Notes:

- 1 Dimensions are in MM
- 2 Mounting of FirePro unit See drawing Y-1260-2
- 3 Mounting of Control Panel See Drawing Y-1260-3

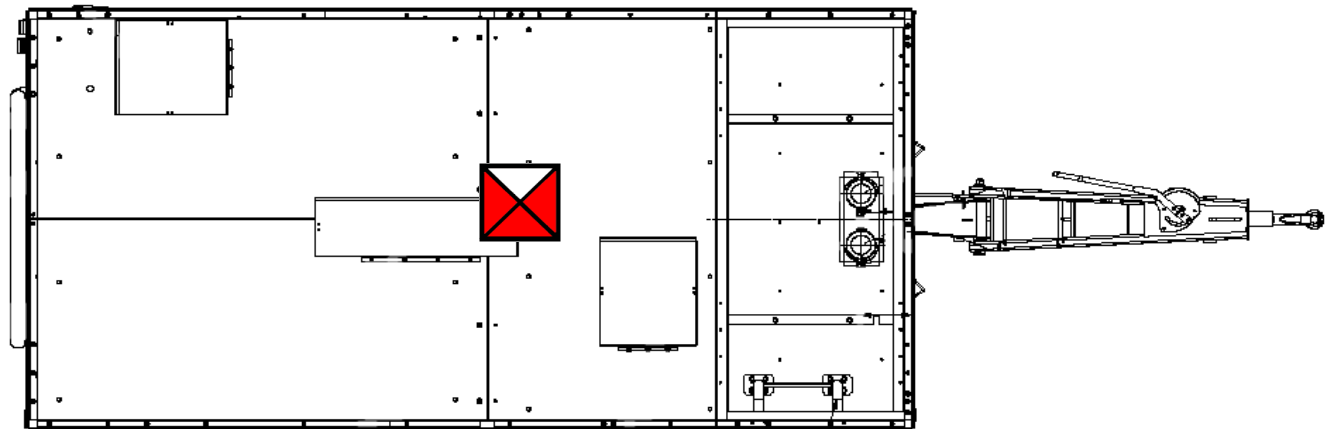
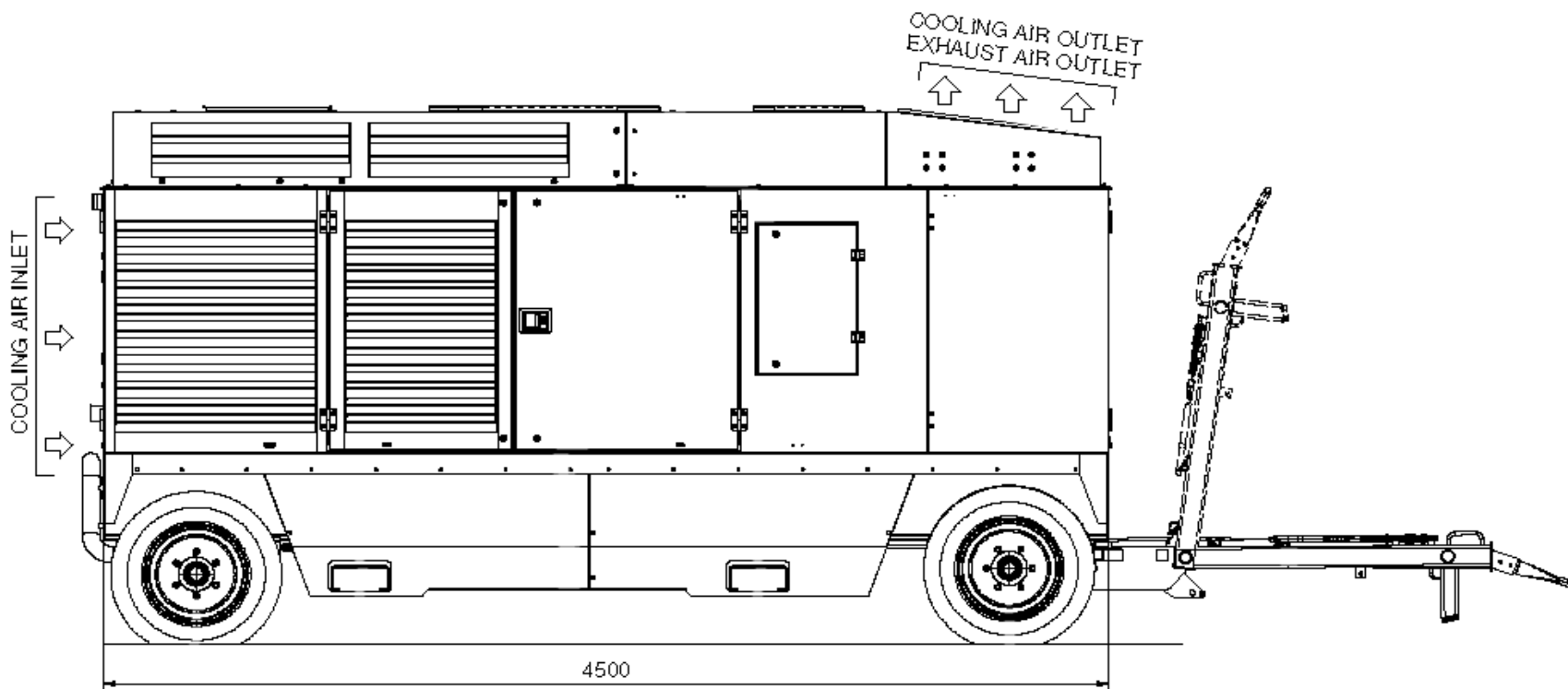
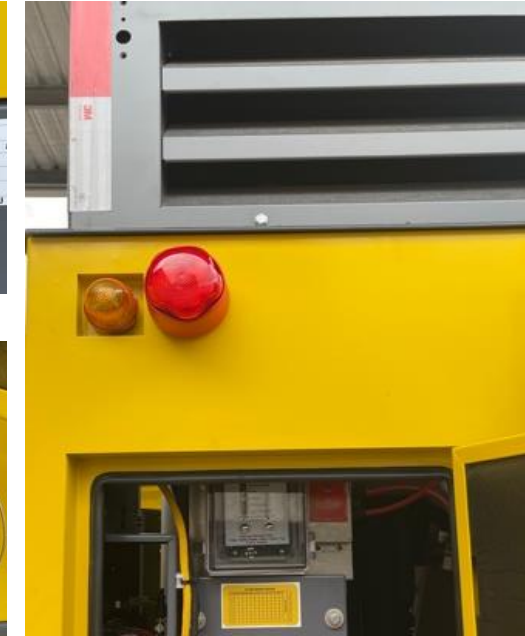

Components :



VSS Control Panel



Siren Strobe



Manual Actuator



FirePro Aerosol
FP-3000S

FIRE SAFETY EQUIPMENT PTY LTD				
Drawn By PM	Approved By	Title	Drawing No	Rev.
Scale No	Date 15-10-19	Atlas Copco Y-1260 CX4004 Controller FirePro System General Arrangement	Y-1260-4004 -1	A

Y-1260 with XC4004 Controller

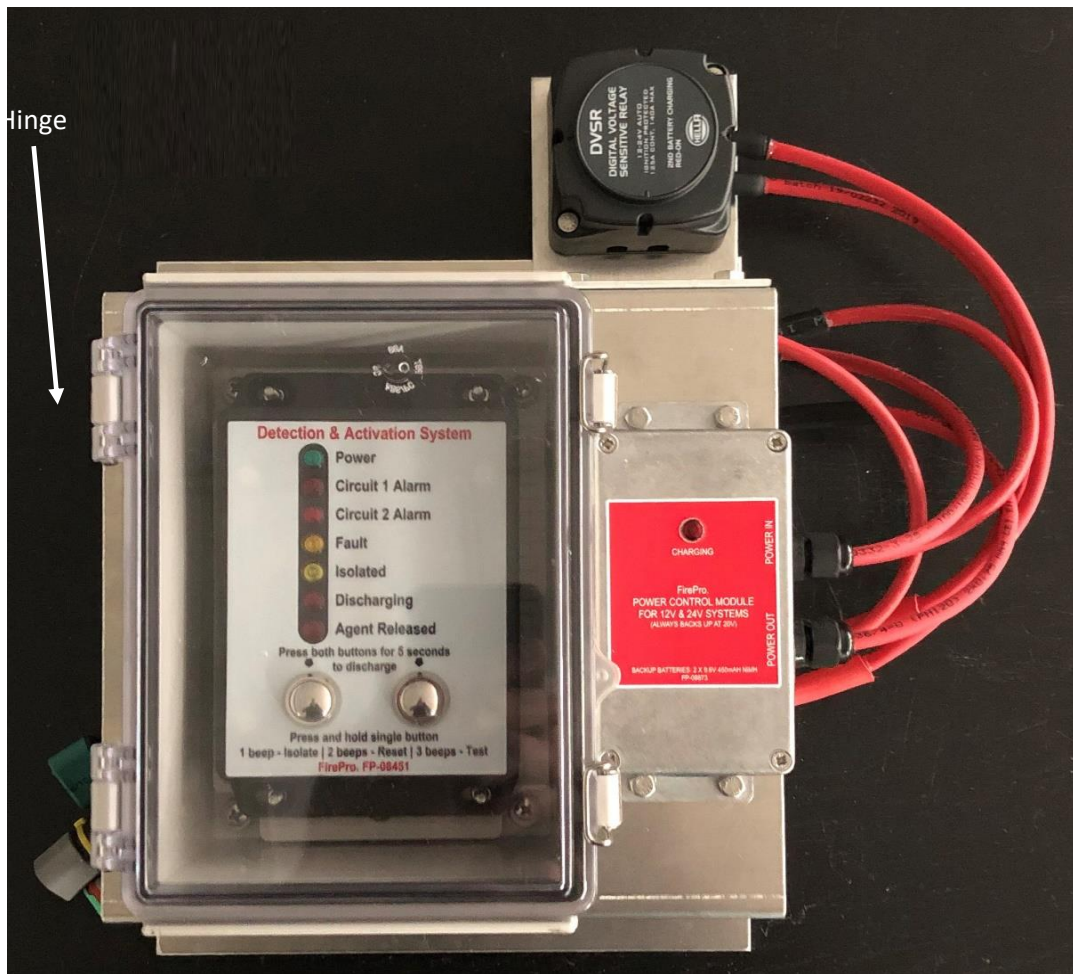

FRONT MOUNTED VIEW

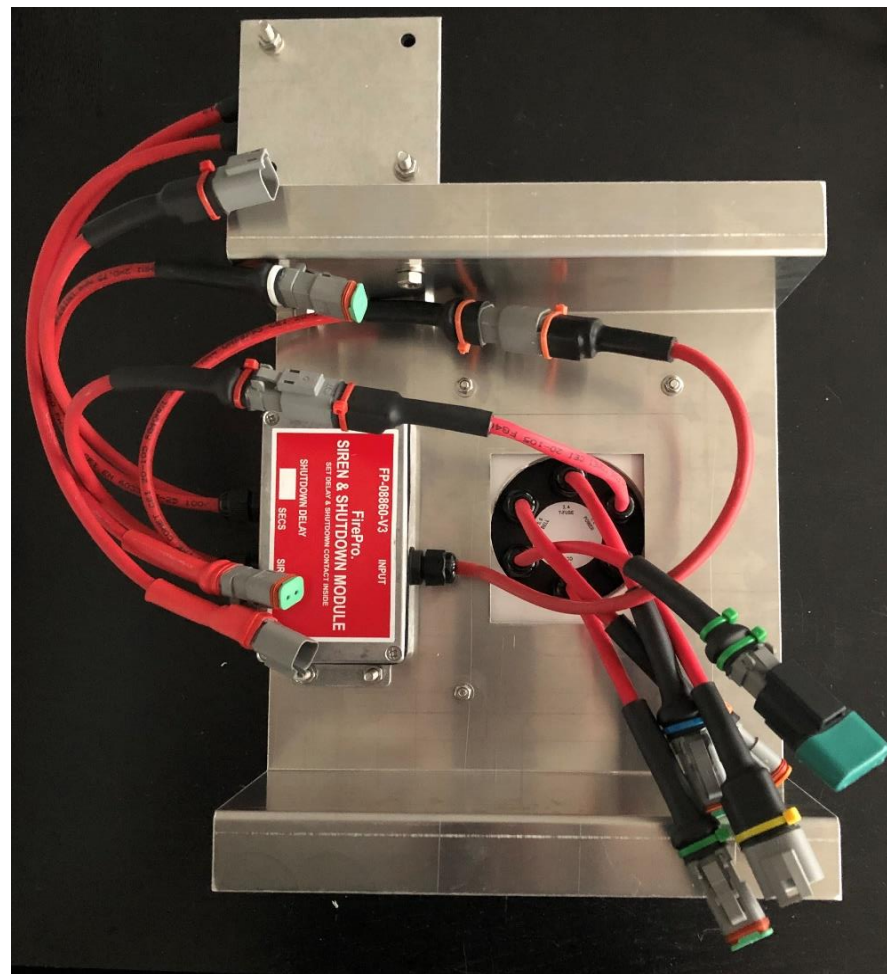

REAR MOUNTED VIEW



INSTALLED VIEW

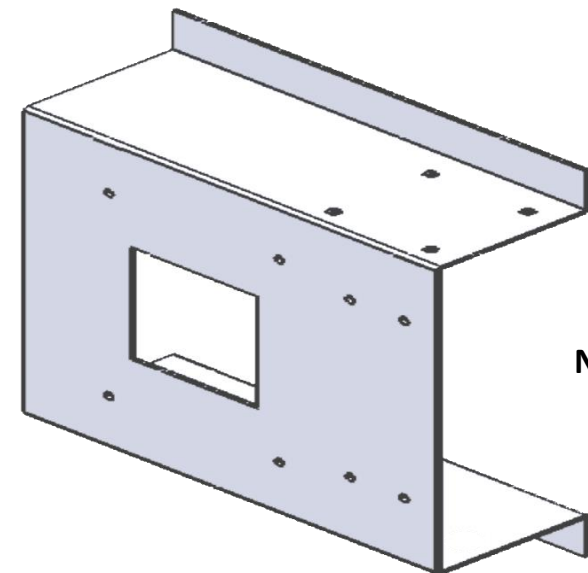
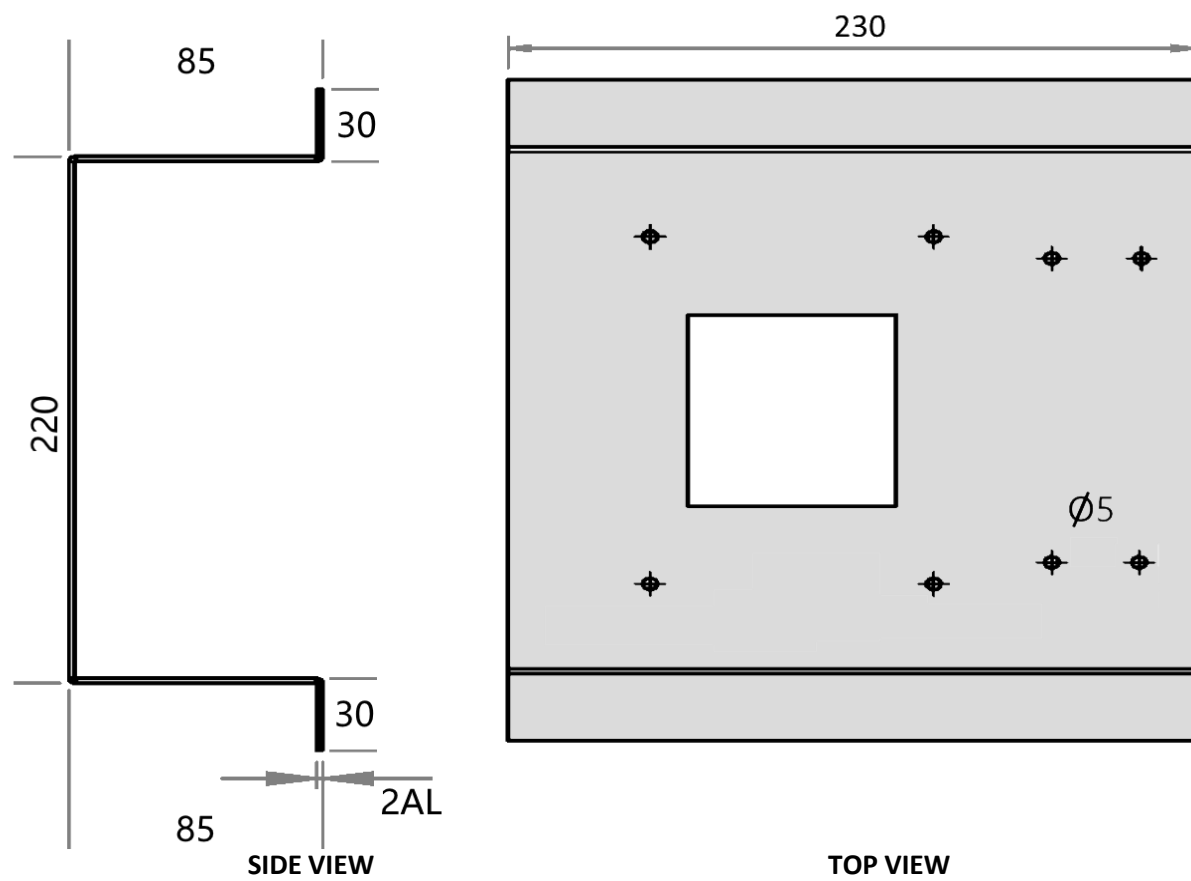













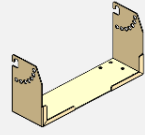



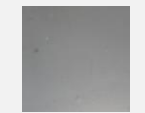



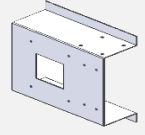

Panel Location

- Notes:**
- 1 Bracket Material - Marine Grade Aluminium 2mm Unpainted
 - 2 Dimensions are in MM
 - 3 Bracket has Provision for all Control Modules on Front
 - 4 Bracket mounts on Predrilled & tapped 8mm holes on floor plate

FIRE SAFETY EQUIPMENT PTY LTD				
Drawn By PM	Approved By	Title	Drawing No	Rev.
Scale No	Date 15-10-19	Atlas Copco Y-1260 XC4004 Controller FirePro Panel Control Panel Mounting	Y-1260-4004-3	A

Y-1260 with XC4004 Controller

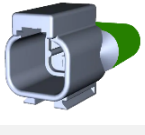
BILL OF MATERIALS

Part No	Qty	Description	Part No	Qty	Description
FP-3000S	1	 3000g SS Aerosol Generator	FP-08860	1	 Shutdown Module - to suit 8451
FP-06100	1	 HD SS Bracket to suit 1200 - 5700	FP-08872	1	 Battery Backup Module 12-24vDC NiMH
FP-08800	1	 FirePro Test Module	FP-14053	2	 External Actuator Switch with Bracket
FP-06910	1	 Dust Seals – to suit FP1200-5700	FP-14016	1	 Battery cable connection x 3m with 5A Fuse 2 Pin Male Deutsch Plug and Battery Terminal Connectors
FP-08451	1	 Control Panel - FirePro detection and Activation Panel	FP-09500	30	 Cable 2 core 0.75mm Shielded FR x 1m
X-Y1260-2	1	 Special Bracket for Mounting Control Equipment on Atlas Copco Y-1260 Compressor	FP-08825	1	 Thermal Fuse with Coupling
DP-3010	2	 Deutsch Plug – 3 Pin Male, c/w pins and heatshrink to suit	FP-08940	1	 Siren / Strobe with EOL diode Installed
DP-3020	2	 Deutsch Plug – 3 Pin Female, c/w pins and heatshrink to suit	FP-09510-08	1	 Linear Heat Detection 180deg C Cable x 8m with 2 pin Deutsch Plugs fitted
DP-2010	4	 Deutsch Plug – 2 Pin Male, c/w pins and heatshrink to suit	Misc	16	 P-clips to suit FP-09510 LHD
DP-2020	4	 Deutsch Plug – 2 Pin Female, c/w pins and heatshrink to suit	FP-08961	1	 Sign - System Warning Vinyl - Vehicle
FP-08950	2	 End of Line Resistor	FP-08879	1	 Voltage Sensitive Relay
FP-08945	1	 WaterProof Enclosure for Control Panel			

FIRE SAFETY EQUIPMENT PTY LTD				
Drawn By PM	Approved By	Title	Drawing No	Rev.
Scale No	Date 15-10-19	Atlas Copco Y-1260 XC4004 Controller Bill of Materials	Y-1260-4004-4	A