

XRVS - 1050 with XC4003 Controller

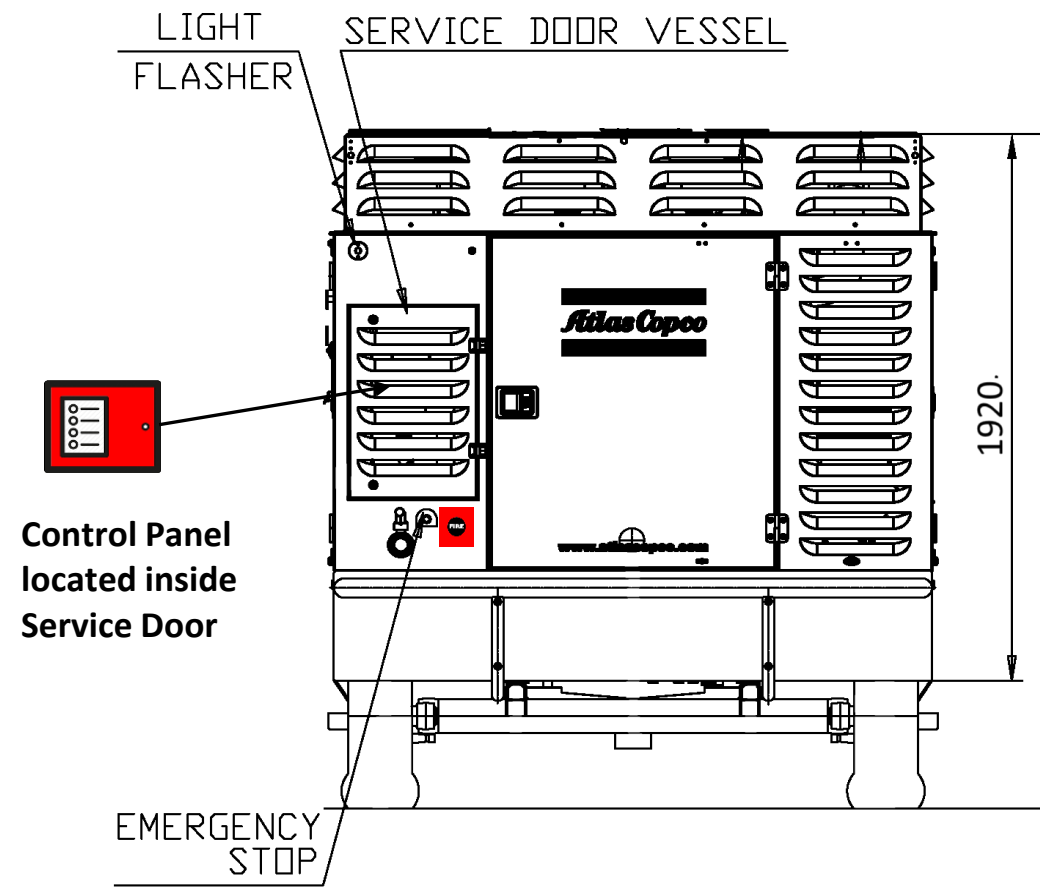

FRONT MOUNTED VIEW

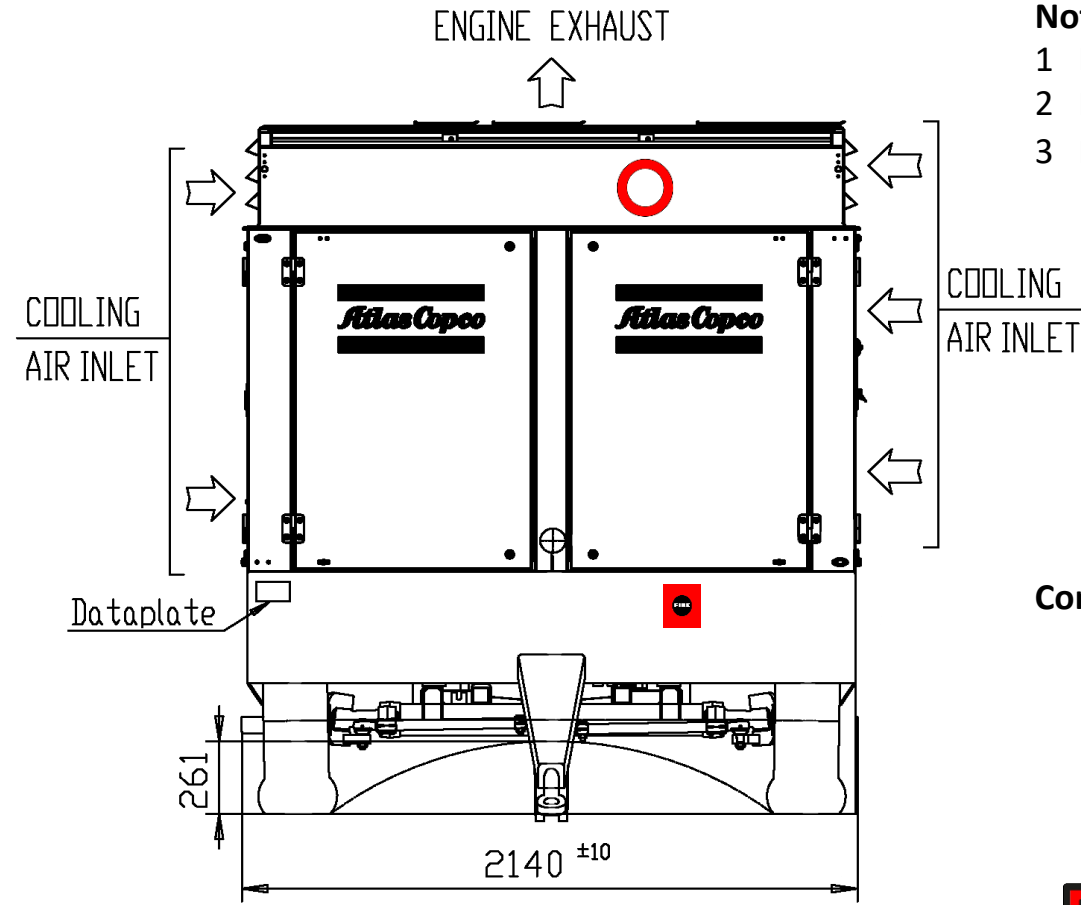





REAR MOUNTED VIEW

Notes:

- 1 Dimensions are in MM
- 2 Mounting of FirePro unit See drawing XRVS-1050-2
- 3 Mounting of Control Panel See Drawing XRVS-1050-3

Components :

-  Manual Actuator
-  Siren Strobe
-  VSS Control Panel
-  FirePro Aerosol Generator - FP-3000S

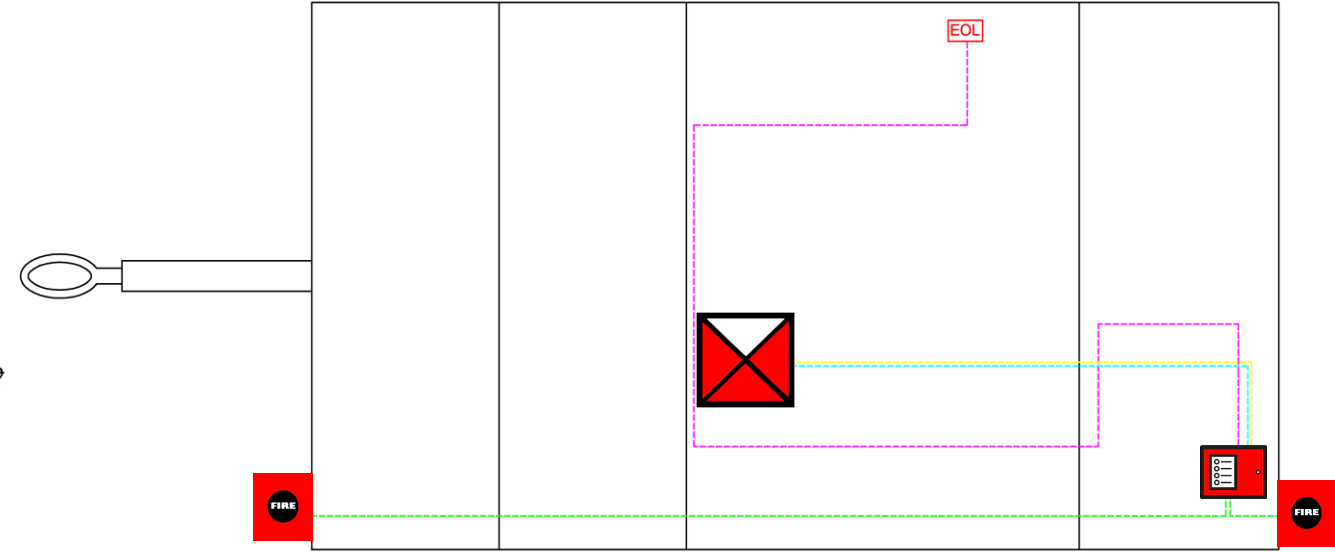
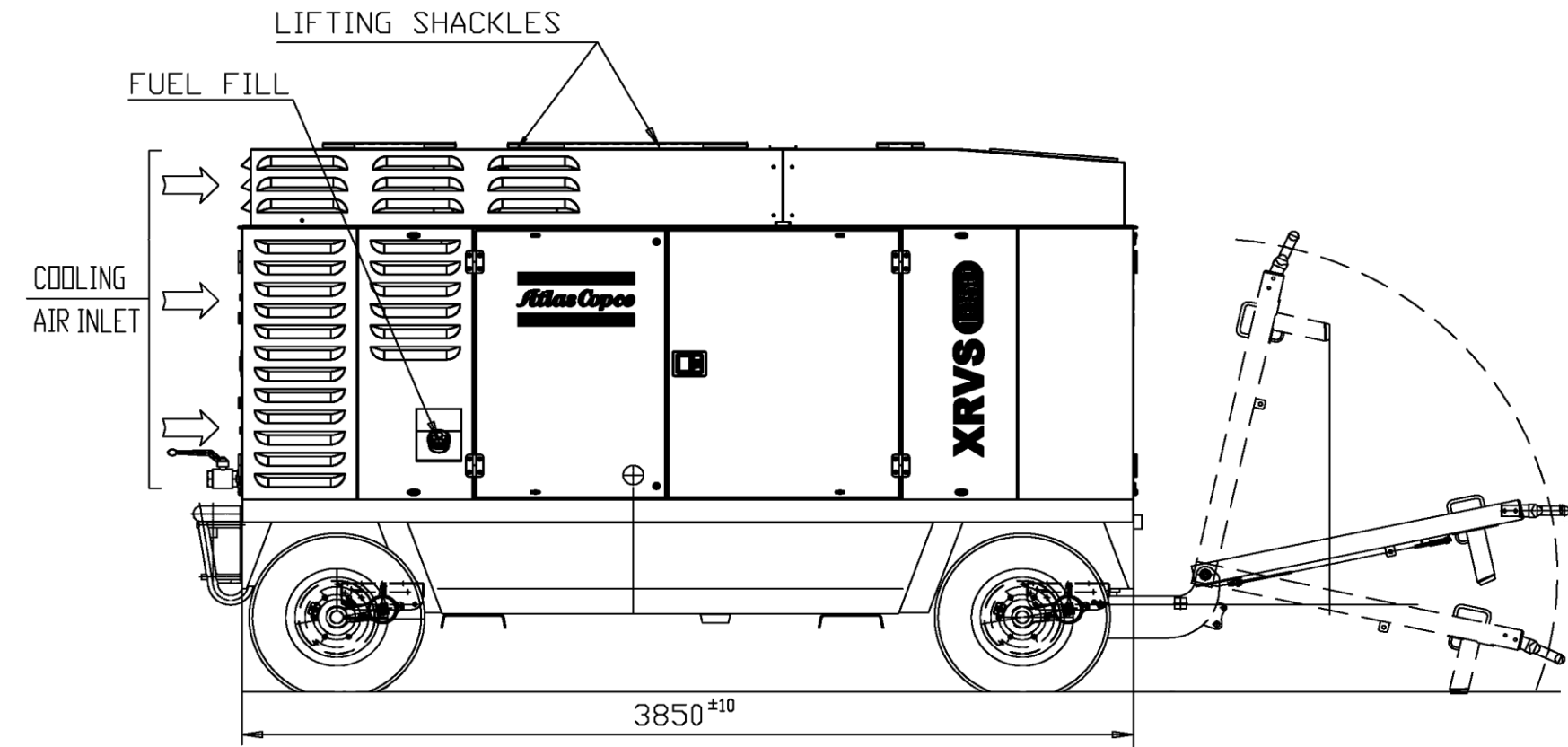

FIRE SAFETY EQUIPMENT PTY LTD				
Drawn By PM	Approved By	Title Atlas Copco XRVS-1050 CX-003 Controller FirePro System General Arrangement	Drawing No XRVS-1050-10	Rev. A
Scale No	Date 15-10-19			

XRVS - 1050 with XC4003 Controller

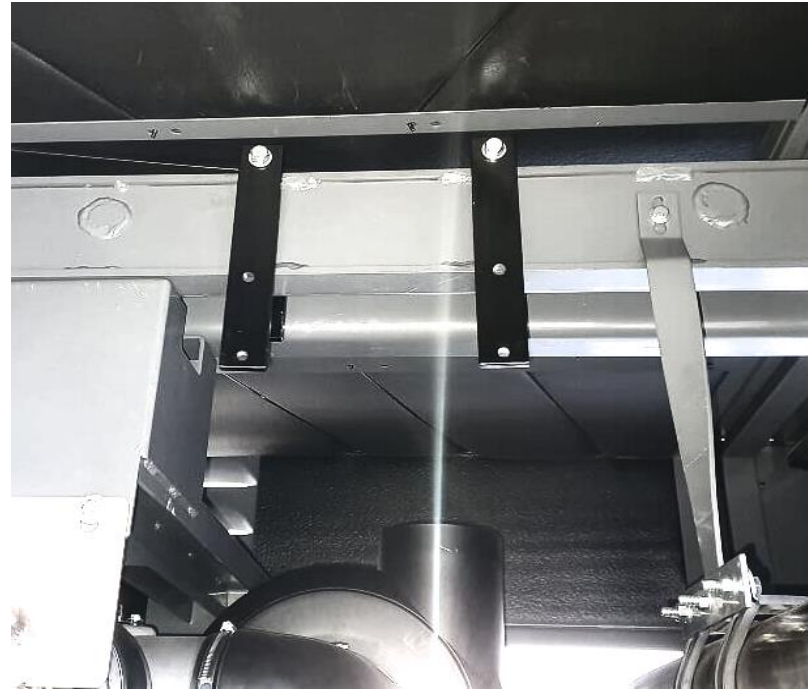

INSTALLED VIEW

2 SETS OF THESE COMPONENTS REQUIRED

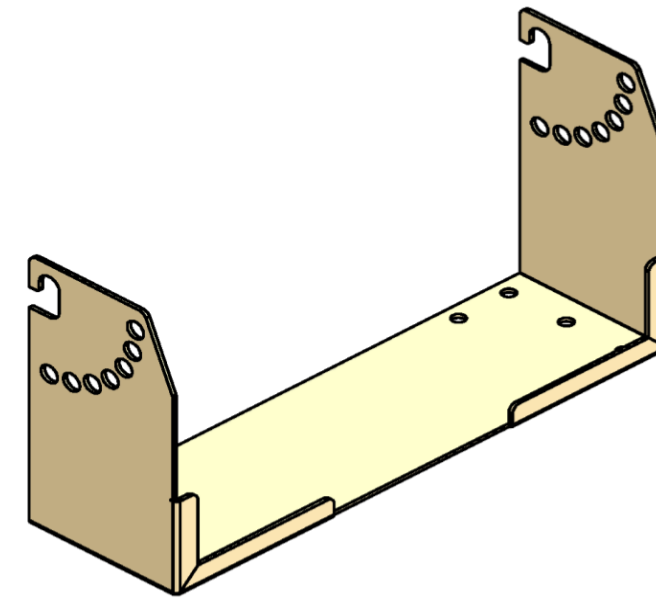
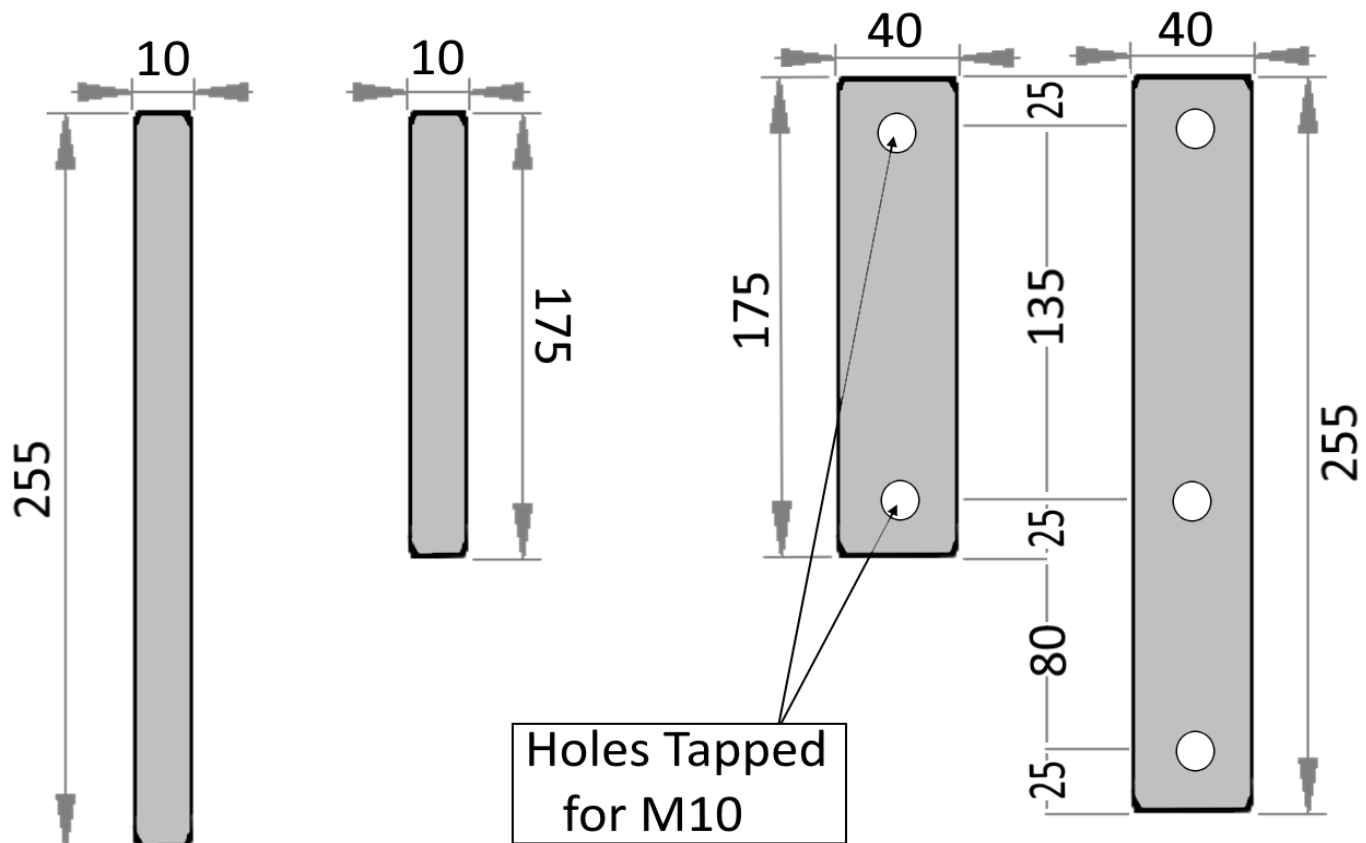

Standard FirePro Bracket

Notes:

- 1 Bracket Material - Mild Steel Bar 40 x 10mm - Painted
- 2 Dimensions are in MM
- 3 Holes in Bracket are for M10 Bolts
- 4 Mount Standard FirePro Bracket as shown

FIRE SAFETY EQUIPMENT PTY LTD				
Drawn By PM	Approved By	Title Atlas Copco XRVS-1050 CX-003 Controller FirePro System General Arrangement	Drawing No XRVS-1050-12	Rev. A
Scale No	Date 15-10-19			

XRVS - 1050 with XC4003 Controller















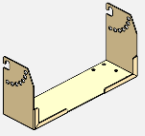







Notes:

- 1 Dimensions are in MM

FIRE SAFETY EQUIPMENT PTY LTD				
Drawn By PM	Approved By	Title Atlas Copco XRVS-1050 CX-003 Controller FirePro System General Arrangement	Drawing No XRVS-1050-13	Rev. A
Scale No	Date 15-10-19			

XRVS - 1050 with XC4003 Controller

BILL OF MATERIALS

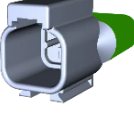
Part No	Qty	Description	Part No	Qty	Description
FP-3000S	1	 3000g SS Aerosol Generator	FP-08860	1	 Shutdown Module - to suit 8451
FP-06100	1	 HD SS Bracket to suit 1200 - 5700	FP-08873	1	 Battery Backup Module 12-24vDC NiMH
FP-08800	1	 FirePro Test Module	FP-14053	2	 External Actuator Switch with Bracket
FP-06910	1	 Dust Seals – to suit FP1200-5700	FP-14016	1	 Battery cable connection x 3m with 5A Fuse 2 Pin Male Deutsch Plug and Battery Terminal Connectors
FP-22408	1	 Control Panel - FirePro detection and Activation Panel	FP-09500	30	 Cable 2 core 0.75mm Shielded FR x 1m
X-XRVS-1050-1	1	 Special Bracket for Mounting FirePro Aerosol Generator on Atlas Copco XRVS-1050 Compressor	FP-08825	1	 Thermal Fuse with Coupling
DP-3010	2	 Deutsch Plug – 3 Pin Male, c/w pins and heatshrink to suit	FP-08940	1	 Siren / Strobe with EOL diode Installed
DP-3020	2	 Deutsch Plug – 3 Pin Female, c/w pins and heatshrink to suit	FP-09510-08	1	 Linear Heat Detection 180deg C Cable x 8m with 2 pin Deutsch Plugs fitted
DP-2010	4	 Deutsch Plug – 2 Pin Male, c/w pins and heatshrink to suit	Misc	16	 P-clips to suit FP-09510 LHD
DP-2020	4	 Deutsch Plug – 2 Pin Female, c/w pins and heatshrink to suit	FP-08961	1	 Sign - System Warning Vinyl - Vehicle
			FP-08950	2	 End of Line Resistor

FIRE SAFETY EQUIPMENT PTY LTD				
Drawn By	Approved By	Title	Drawing No	Rev.
PM		Atlas Copco XRVS-1050 CX-003 Controller	XRVS-1050-14	A
Scale	Date	FirePro System General Arrangement		
No	15-10-19			