

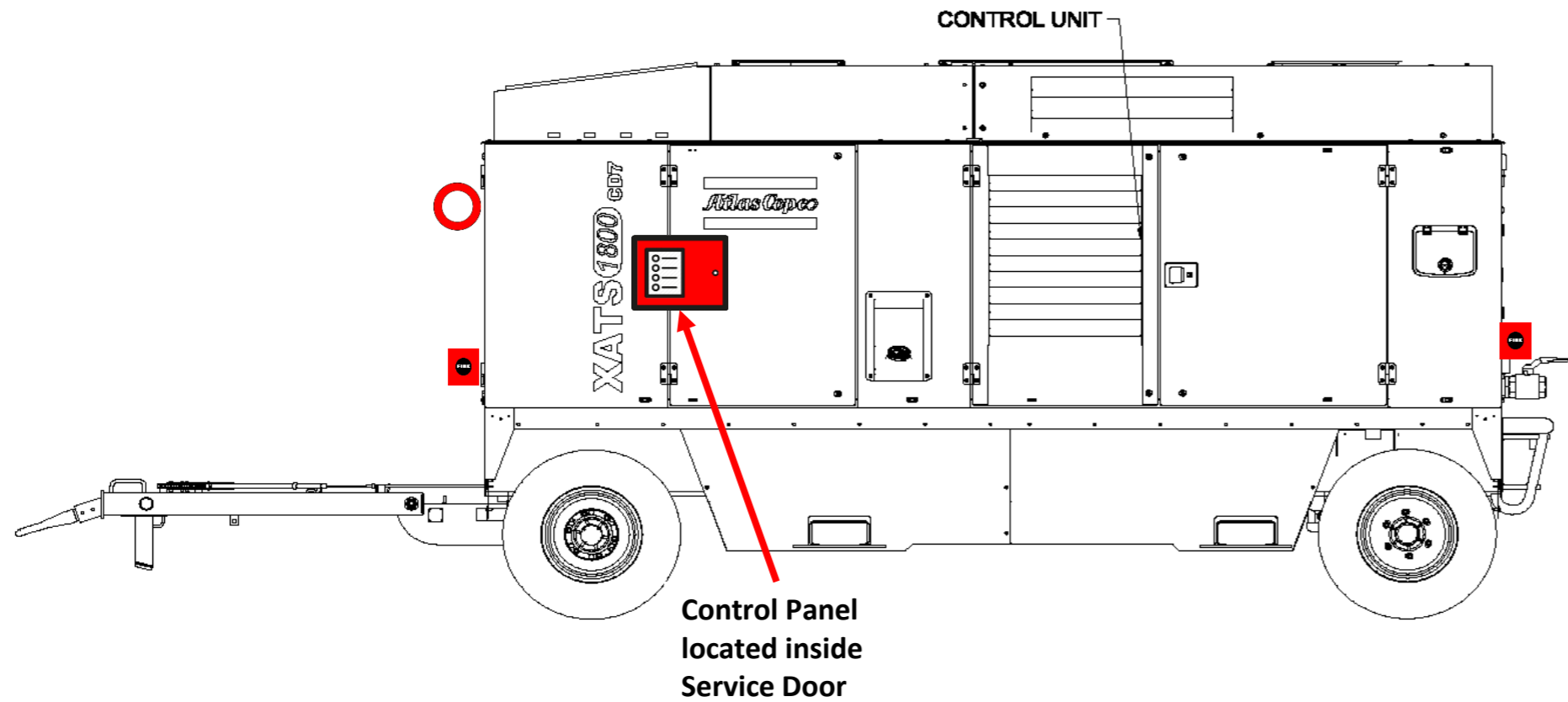



XAVS-1800



Notes:



- 1 Dimensions are in MM
- 2 Mounting of FirePro unit See drawing XATS-800-2
- 3 Mounting of Control Panel See Drawing XATS-800-3

Components :

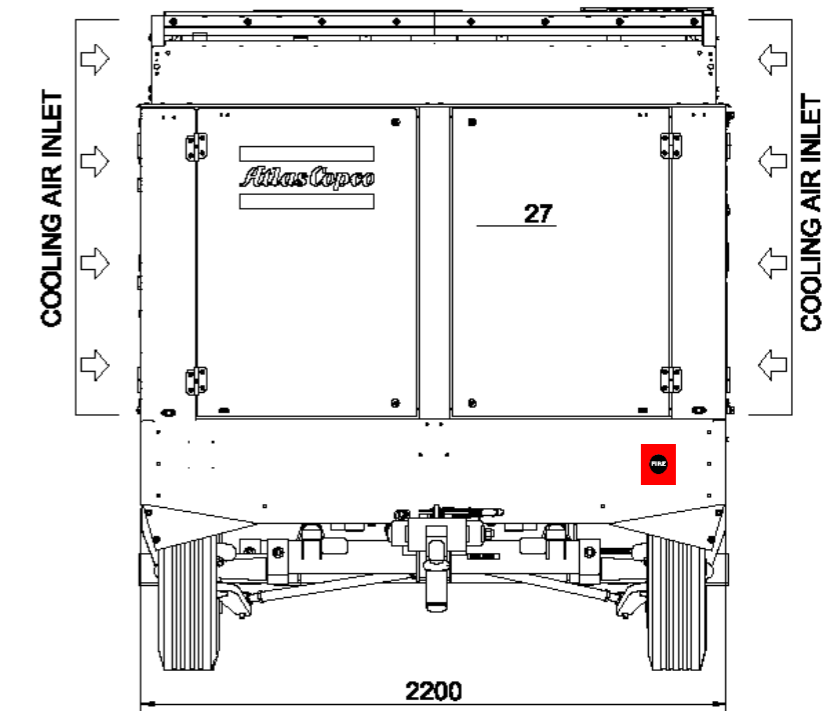
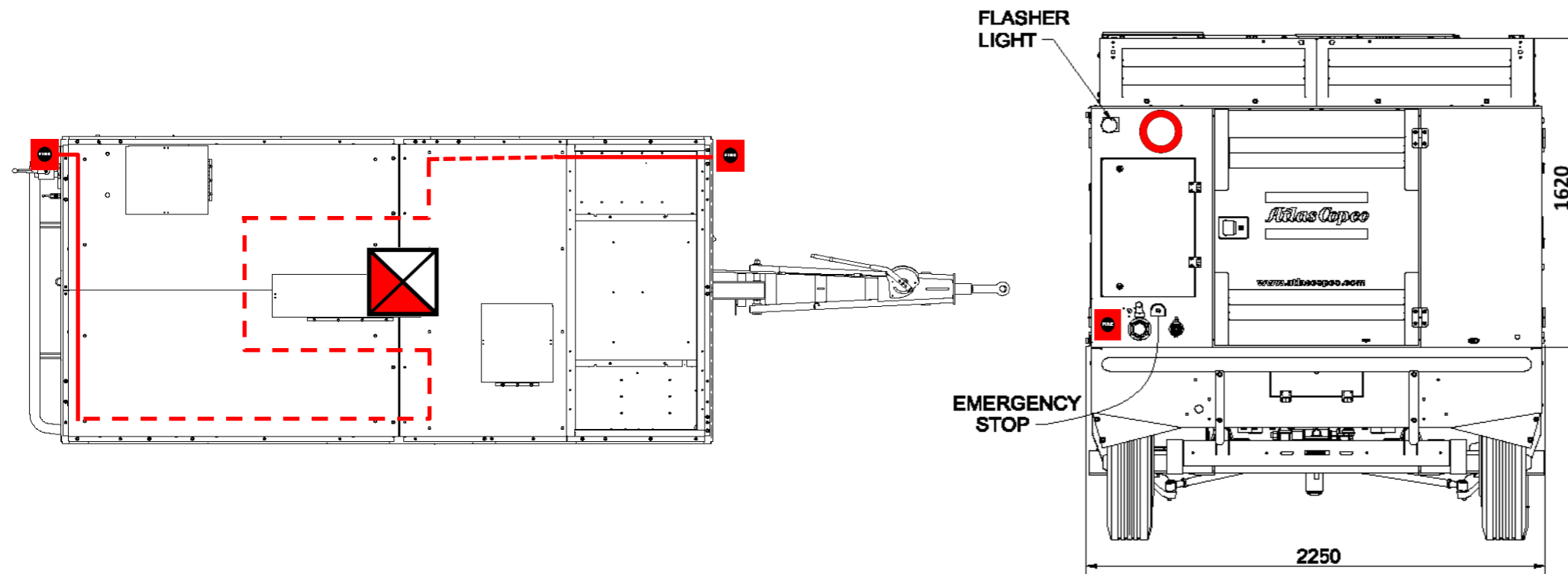
-  Manual Actuator
-  Siren Strobe
-  VSS Control Panel
-  FirePro Aerosol Generator - FP-2000S



Notes:

- 1 Dimensions are in MM
- 2 Mounting of FirePro unit See drawing XRVS-1800-2
- 3 Mounting of Control Panel See Drawing XRVS-1800-3
- 4 Detection Circuit 1  Linear Heat Detection 

FIRE SAFETY EQUIPMENT PTY LTD					
Drawn By PM	Approved By	Title	Atlas Copco XAVS-1800 FirePro System General Arrangement	Drawing No XAVS-1800-1	Rev. E
Scale No	Date 15-10-19				

XAVS-1800

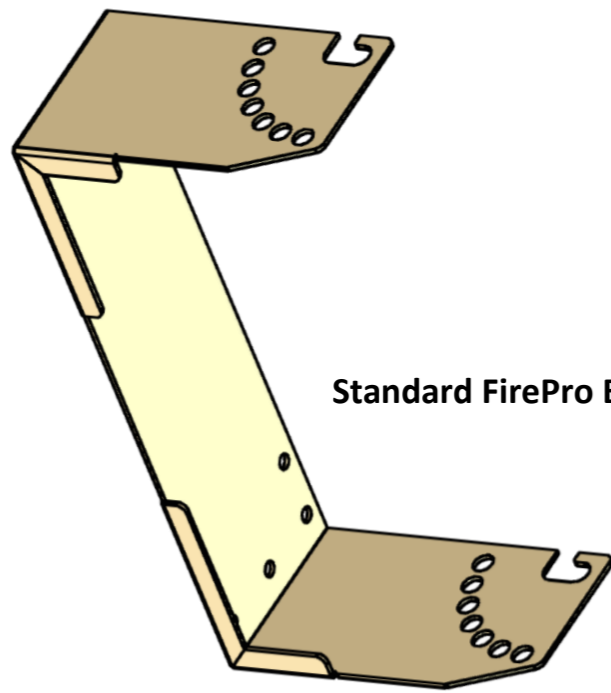

Standard FirePro Bracket



INSTALLED VIEW



Notes:

- 1 Bracket Material - 316SS 2.5mm
- 2 Dimensions are in MM
- 3 Holes in Bracket are for M8 Bolts
- 4 Mount Standard FirePro Bracket as shown

FIRE SAFETY EQUIPMENT PTY LTD				
Drawn By PM	Approved By	Title	Drawing No	Rev.
Scale No	Date 15-10-19	Atlas Copco XAVS-1800 FirePro System General Arrangement	XAVS-1800-2	E

XAVS-1800

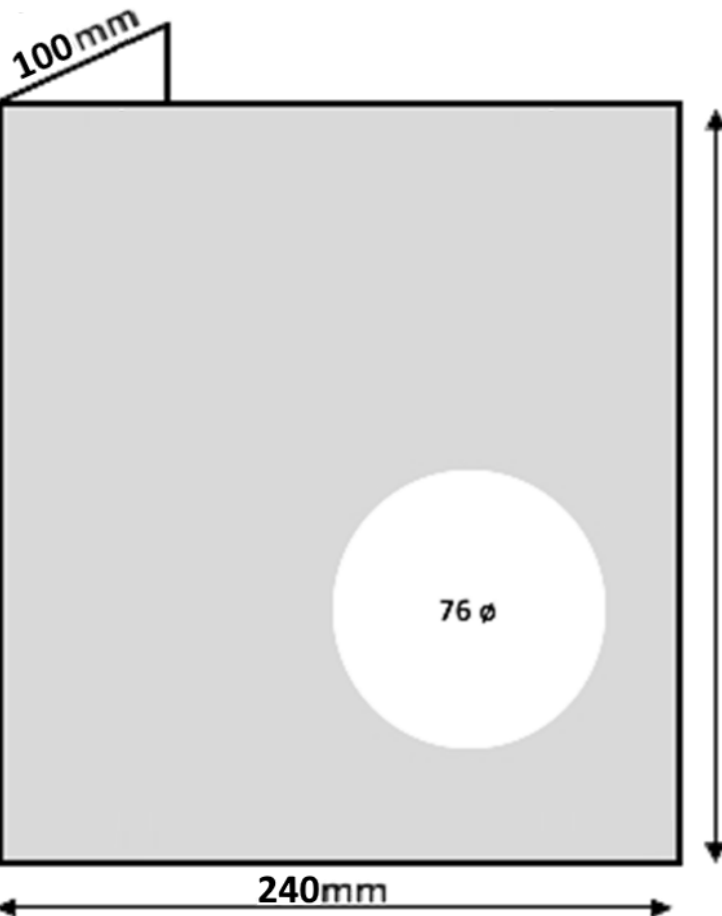

Cable exposed to direct sunlight is to be in Conduit

INSTALLED VIEW















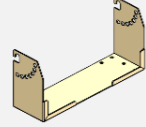



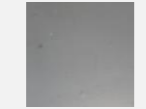



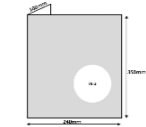

Notes:

- 1 Dimensions are in MM
- 2 1 Bracket are required for each unit
- 3 Material Marine Grade Alum 4mm

FIRE SAFETY EQUIPMENT PTY LTD				
Drawn By PM	Approved By	Title	Drawing No	Rev.
Scale No	Date 15-10-19	Atlas Copco XAVS-1800 FirePro System General Arrangement	X-XAVS-1800-3	E

XAVS-1800

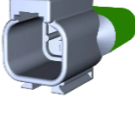
BILL OF MATERIALS

Part No	Qty	Description	Part No	Qty	Description
FP-2000S	1	 2000g SS Aerosol Generator	FP-08860	1	 Shutdown Module - to suit 8451
FP-06100	1	 HD SS Bracket to suit 1200 - 5700	FP-08872	1	 Battery Backup Module 12-24vDC NiMH
FP-08800	1	 FirePro Test Module	FP-14053	2	 External Actuator Switch with Bracket
FP-06910	1	 Dust Seals – to suit FP1200-5700	FP-14016	1	 Battery cable connection x 3m with 5A Fuse 2 Pin Male Deutsch Plug and Ballery Terminal Connectors
FP-08451	1	 Control Panel - FirePro detection and Activation Panel	FP-09500	30	 Cable 2 core 0.75mm Shielded FR x 1m
FP-08918	1	 Splitter Cable, Red, No TVS	FP-08825	1	 Thermal Fuse with Coupling
FP-92900	1	 Control Panel Mounting Bracket	FP-08940	1	 Siren / Strobe with EOL diode Installed
DP-3010	2	 Deutsch Plug – 3 Pin Male, c/w pins and heatshrink to suit	FP-09510-08	1	 Linear Heat Detection 180deg C Cable x 8m with 2 pin Deutsch Plugs fitted
DP-3020	2	 Deutsch Plug – 3 Pin Female, c/w pins and heatshrink to suit	Misc	16	 P-clips to suit FP-09510 LHD
DP-2010	4	 Deutsch Plug – 2 Pin Male, c/w pins and heatshrink to suit	FP-08961	1	 Sign - System Warning Vinyl - Vehicle
DP-2020	4	 Deutsch Plug – 2 Pin Female, c/w pins and heatshrink to suit	FP-08950	2	 End of Line Resistor
FP-08945	1	 WaterProof Enclosure for Control Panel			

FIRE SAFETY EQUIPMENT PTY LTD					
Drawn By PM	Approved By	Title	Atlas Copco XAVS-1800 FirePro System General Arrangement	Drawing No XAVS-1800-4	Rev. E
Scale No	Date 15-10-19				